

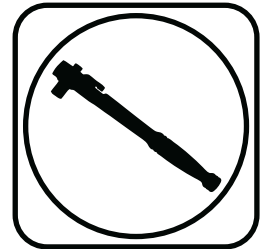

Part # 11053699 - 1958-1964 GM B-Body Front Upper StrongArms



Recommended Tools



1958-1964 GM B-Body Upper StrongArms Installation Instructions

Table of contents

- Page 2..... Upper Control Arm Components
- Page 3..... Getting Started & Installation
- Page 4..... Installing Spindle and Alignment

THESE CONTROL ARMS ARE DESIGNED TO BE USED WITH THE 1959-1964 **OEM** SPINDLES.





Upper Control Arm ComponentsIn the box

Item #	Part Number	Description	QTY
1	90001296	Driver Upper Control Arm (Shown)	1
1	90001297	Passenger Upper Control Arm	1
2	90000905 kit	Upper Ball Joint Kit - Proforged # 101-10038	2
3	90000927	Cross Shaft Kit - contains 2 cross shafts	2
4	70014457	Delrin Bushing	4
5	90001290	Delrin Bushing Inner Sleeve	4
6	99373001	Outer Washer - Cross Shaft	4
7	99373005	3/8" Split Lock Washer -Cross Shaft	4
8	99371014	3/8"-24 x 1 1/4" Hex Bolt - Cross Shaft	4

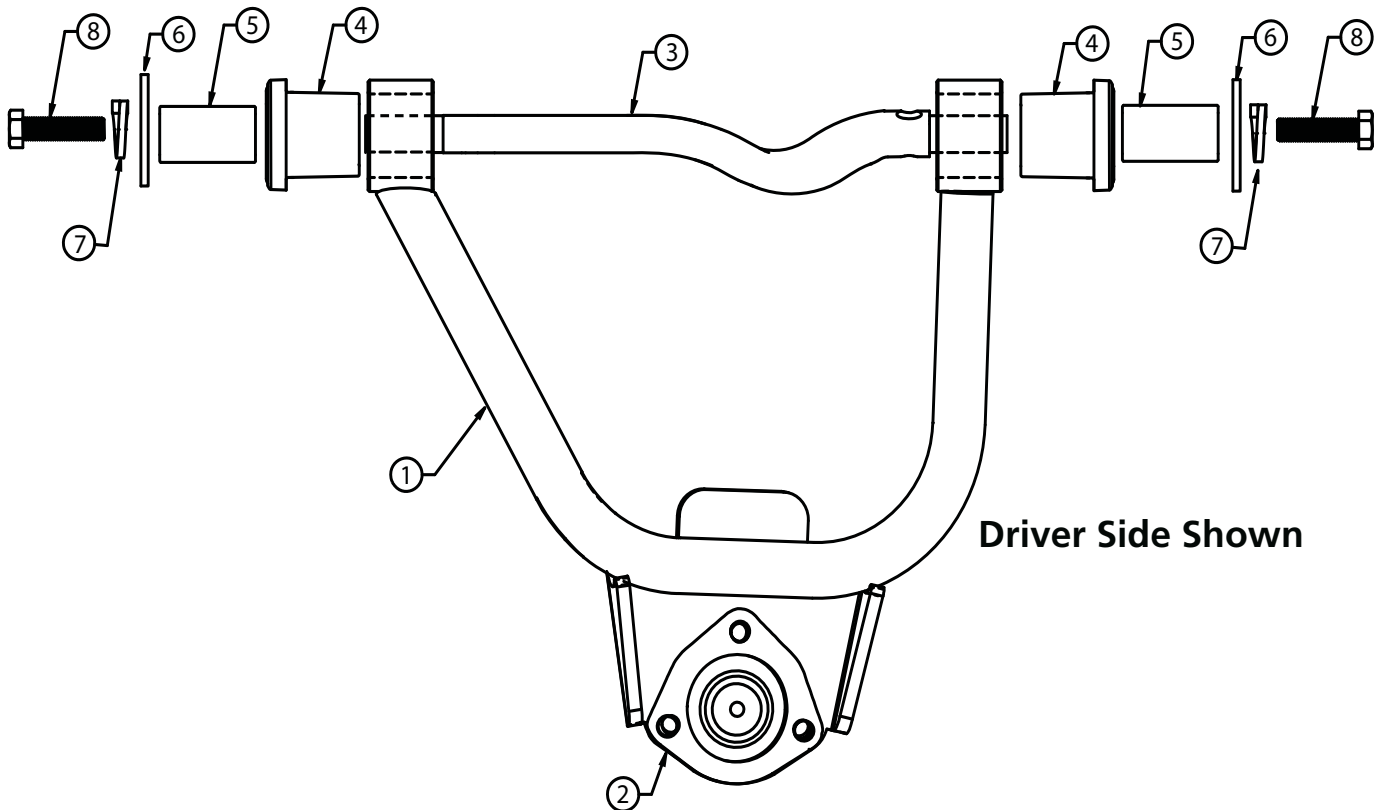



Getting Started.....

Congratulations on your purchase of the Ridetech StrongArms. These StrongArms have been designed to give your car excellent handling along with a lifetime of enjoyment. Some of the key features of the StrongArms: Ball joint angles have been optimized for the lowered ride height, Delrin bushings are used to eliminate bushing deflection along with providing free suspension movement through the entire travel. The Delrin bushings are made from a material that is self lubricating so no grease zerks are needed.

Installation

1. Remove the upper control arms from the car. Keep the shims separate so that you can put them back in the location they were removed from. If you are replacing the lower control arms and spindle, remove them too. Refer to a Factory Service Manual for the proper method.

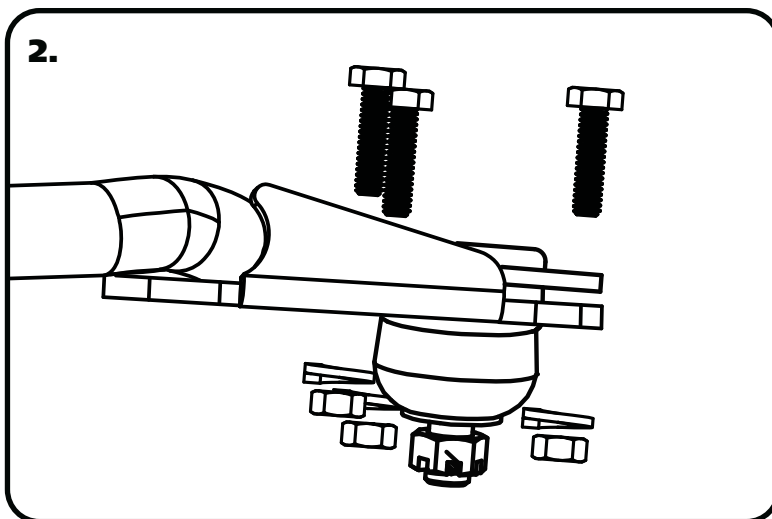

2. Insert the Ball Joint into the Control Arm from the TOP side with the Stud pointing downward. Insert the supplied Bolts from the top side. Install a Lock Washer and Hex Nut on the threads of each bolt. Torque the hardware to 18 ftlbs.

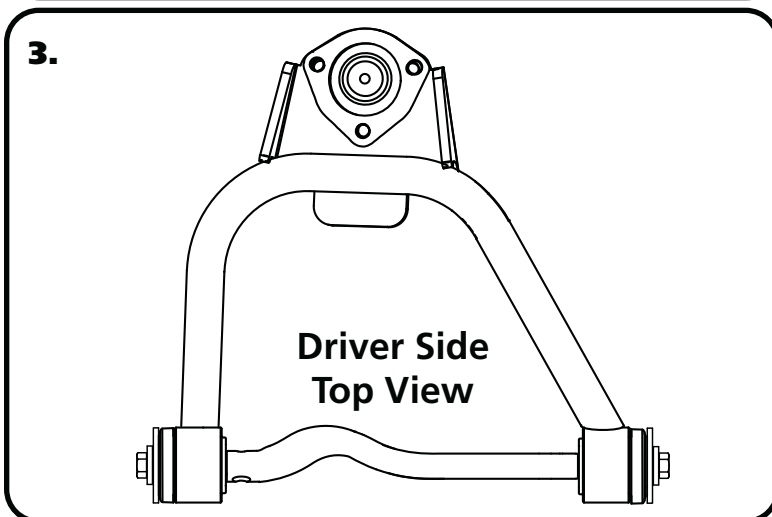

3. The Upper Control Arm is attached to the factory frame using factory hardware. The driver side arm is shown in **Figure "3"**. The Ball joint is located on the arm to the REAR of the car.



Installing Spindle and Alignment



4. The Upper Control Arm is attaching the factory mount using factory hardware. Reinstall the shims in the location they were removed from. The passenger side arm is shown in **Figure "4"**. Torque the OEM nuts to 50 ft-lbs.

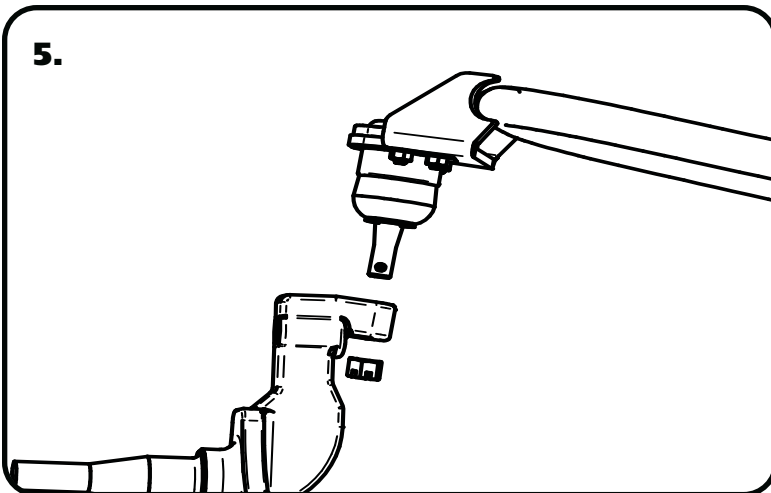

5. Attach the Spindle to the control arms. These control arms use a tall ball joint, the boot will NOT touch the spindle. This is normal.

Torque Specs:

Ball joint - 45 ftlbs and tighten to line up cotter pin.

Install the Cotter Pin after tightening the ball joint nut.

6. Tighten all fasteners.

Suggested Alignment Specs:

Camber: Street: -.5 degrees
Caster: Street: +3.0 to + 5.0 degrees
Toe: Street: 1/16" to 1/8" toe in