

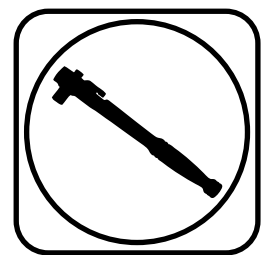

Part # 1165010/1165110 - 1967-1969 GM F-Body StreetGrip

Front Components	
11169590	Delrin Control Arm Bushings
90000894	Tall Upper Ball Joint
11162350/11162351	Front Dual Rate CoilSprings
22149846	Front HQ Series Shocks
11169120	Front Sway Bar
Rear Components	
11164800	Composite Leaf Springs
11165399	Delrin Leaf Spring Bushings
22189842	Rear HQ Series Shocks

Recommended Tools



1967-1969 GM F-Body Street Grip Installation Instructions

Table of contents	
Page 2.....	Major components and Hardware List
Page 3.....	Getting Started
Page 4-6.....	Delrin Bushings
Page 7-8.....	Tall Upper Ball Joint
Page 9.....	Front Dual Rate CoilSpring
Page 10-12.....	Front Sway Bar
Page 15-18.....	Composite Leaf Springs & Delrin Bushings
Page 19-22.....	Front and Rear HQ Series Shocks

The majority of the StreetGrip components will be installed together. For example, the Front CoilSprings, Ball Joint, Control Arm Bushings and Shocks will be installed in conjunction with each other. On the rear, the CoilSprings and Shocks will be installed in conjunction with each other. The front Sway Bar will need to be attached to the frame **before** the rest of the components are installed.



Major ComponentsIn the box

Part #	Description	QTY
55480700/55518800	Front CoilSprings- Small Block/Big Block	2
90002550	Rear Leaf Springs w/ Delrin Bushings & Inner Sleeves Installed	2
90002497	Leaf Spring Clamp Plate	4
90000894	Tall Upper Ball Joint	2
90000898	Lower Ball Joint	2
70012382	Delrin Bushing Outer Shell - Upper Control Arm - Small Lower	4
70012385	Delrin Bushing Outer Shell - Lower Control Arm - Large Lower	2
70012386	Delrin Bushing Outer Shell - Lower Control Arm	2
70012419	Delrin Bushing - Upper Control Arm	4
70012423	Delrin Bushing - Lower Control Arm - Small Lower	2
70012424	Delrin Bushing - Lower Control Arm - Large Lower	2
90002521	Upper Control Arm Bushing Inner Sleeve - Upper	4
90000516	Lower Control Arm Bushing Inner Sleeve - Lower	4
	Front & Rear Shocks	
986-10-042	4.75" Stroke Stud Top Shock - Front	2
70011139	5/8" ID Shock Bushing (Installed in Shock) - Front	2
90002069	Standard T-bar (Installed in Shock) - Front	2
70011140	Stud Top Bushing - Front & Rear	8
70011141	Stud Top Bushing Washer - Front & Rear	8
99372006	3/8"-24 Jam Nut - Front & Rear	8
986-10-049	7.55" Stroke Stud Top Shock - Rear	2
70011138	3/4" ID Shock Bushing (Installed in Shock) - Rear	2
90002103	5/8" ID Shock Sleeve	2
90002102	1/2" ID Shock Sleeve (Installed in Shock)	2
90001619	Shock Bolt Kit	2
90000471	Cantilever Pin Spacer	2
11169120	Front Swaybar Kit	1
90002496	Leaf Spring Shackle Plates	4
70012428	Frame Shackle Bushing	4
90000526	Frame Shackle Inner Bushing Sleeve	2



Getting Started.....

Congratulations on your purchase of the Ridetech StreetGrip Kit. This system has been designed to give your Car excellent ride and handling along with a lifetime of enjoyment. Some of the key features of this Kit: Dual Rate CoilSprings, Composite Leaf Springs, Delrin Control Arm & Leaf Spring Bushings, Larger Swaybar with Delrin Liners and a Taller Upper Ball Joint.

The majority of the StreetGrip Components will be installed together. For example, the Front CoilSprings, Ball Joint, Control Arm Bushings and Shocks will be installed in conjunction with each other. On the rear, the Leaf Springs, Delrin Bushings and Shocks will be installed in conjunction with each other. The front Sway Bar will need to be ATTACHED to the frame BEFORE the rest of the front components are installed. The Sway Bar installation will be finished after the rest of the front components are installed.

Hardware Kit#99010061

The StreetGrip Kit is supplied with a hardware kit. This hardware kit contains individual bags for the different kits within the main kit. The bags are labeled to help determine the correct hardware for the installation of the specific kits. The instructions will aid you in selecting the correct hardware for each component. The bags included in this kit are:

- Front Sway Bar Kit
- Control Arm Kit
- Leaf Spring Kit
- Mono Leaf

Front Suspension

The front components that will need to be installed are: Control Arm Bushings, Upper Ball Joints, Shocks, and CoilSprings. The Sway Bar needs to be ATTACHED to the frame BEFORE the rest of the front components are installed.

If you have never done this type of work before, we recommend getting a Factory Service Manual for proper procedures of disassembly and reassembly of the components for your car.

Rear Suspension

The rear components that will be installed are; rear Composite Leaf Springs, Delrin Leaf Spring Bushings, and rear HQ Series Shocks. The Composite Leaf Springs and Delrin Leaf Spring Bushings will be installed at the same time. The Delrin Leaf Spring Bushings are preinstalled in the Leaf Springs.

Alignment Specs

Anytime you change suspension components, you should have the car alignment checked.

Suggested Alignment Specs:

- Camber: Street: -.5 degrees
- Caster: Street: +3.0 to + 5.0 degrees
- Toe: Street: 1/16" to 1/8" toe in



Part # 11169590 - 1967-1969 F-Body Delrin Control Arm Bushings



Recommended Tools

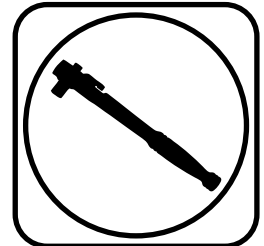

1967-1969 F-Body Delrin Control Arm Bushings Installation Instructions

Table of contents

Page 5..... Included Components and Hardware List

Page 6..... Bushing Installation

IF YOUR CAR HAS AN OVAL BUSHING IN THE LOWER CONTROL ARM, IT WILL BE NECESSARY TO PURCHASE CONTROL ARMS THAT UTILIZE 2 ROUND BUSHINGS.



Major ComponentsIn the box

Part #	Description	QTY
70012382	Upper Control Arm Bushing Outer Shell - Upper	4
70012385	Lower Control Arm Bushing Outer Shell and Inner Sleeve - Small Lower	2
70012386	Lower Control Arm Bushing Outer Shell and Inner Sleeve - Large Lower	2
70012419	Delrin Upper Control Arm Bushing	4
70012423	Delrin Lower Control Arm Bushing - Small Lower	2
70012424	Delrin Lower Control Arm Bushing - Large Lower	2
90002521	Upper Control Arm Bushing Inner Sleeve - Upper	4
90000516	Lower Control Arm Bushing Inner Sleeve - Lower	4

Hardware Bag - Control Arm Kit

Part #	Description	Usage	QTY
99501006	1/2" -13 x 3 1/2" Hex Bolt	Lower Control Arm to Frame	4
99502009	1/2" -13 Nylok Nut	Lower Control Arm to Frame	4
99373005	3/8" Split Lock Washer	Upper Control Arm Shaft Bolts	4

Getting Started.....

The Front Control Arms will need to be removed from the car. Refer to the Factory Service Manual for disassembly procedure.

This F-Body Bushing Kit contains: 4 Upper Control Arm Bushing Assemblies and 4 Lower Control Arm Bushing Assemblies. The Upper Bushings are all the same; there are 2 different diameter Lower Bushings with the larger diameter Bushing being the Rear Bushing. Be sure to match the correct Bushings with the correct locations.

There are several different ways that the Bushings can be removed from the Control Arms. If you have an Air Chisel, a Wide Flat Bit works well. If you don't have access to an Air Chisel, they can be removed by first, Drilling out the rubber with a Hand Drill and Drill Bit. With the Rubber removed, distort the Bushing Shell with a Hammer and Chisel and Knock it out. No matter the process used, the main objective is to **NOT** distort the Control Arm.

WE RECOMMEND MARKING DRIVER AND PASSENGER CONTROL ARMS AND CROSS SHAFTS. ALSO, MARK THE ORIENTATION OF THE CROSS SHAFTS.

1. Measure the Outside Width of the Control Arms and write it down before starting Bushing Removal. You will use this Dimension to check the Control Arms after the new Delrin Bushings are installed.



Delrin Bushing Installation

The Cross Shaft must be put in place before installing the Bushing Shells in the Upper Control Arm.

Just like Bushing Removal, there are several ways the Delrin Bushing Assemblies can be installed. No matter the method used, the Control Arm needs to be **SUPPORTED** to keep from distorting the Control Arm. We recommend cutting spacers to go inside the Control Arms when using a Press to install the Bushings. We have used several different methods to install the Bushing Assemblies, we are going to cover the one that worked best for us. When installing the Bushings, the Outer Shell will be installed in the Arm by itself. Next, Press in the Delrin Bushing, followed by the Inner Sleeve. **WE DO NOT RECOMMEND INSTALLING THE BUSHINGS COMPLETELY ASSEMBLED.**

Note: The Delrin is self-lubricating, no lubricant is needed.



2. Disassemble the Bushing being installed. If installing Bushings in the Upper Control Arm, insert the Cross Shaft before installing any Bushings. Support the Back Side of the Flange the Bushing is being Installed in. Use a STIFF piece of Metal clamped in a Bench Vise for the Lower Control Arms **(Figure 2)**. The Upper Control Arm can be supported by either the same piece of Metal or by the Bench Vise with the Jaws opened wide enough to let the Bushing Shell pass through **(Figure 3)**.



3. Use another Piece of Metal or Strong Wood to Drive the Outer Shell into the Control Arm until the Shell stops against the Control Arm.

4. Press the Delrin Bushing into the Bushing Shell followed by the Inner Sleeve. **DO NOT DRIVE IN WITH HAMMER.**

5. Reinstall the Outer Washer using the OEM Bolt, but replace the Lock Washer with the supplied Lock Washer. Tighten Hardware to eliminate any gaps between the Bushings and Cross Shaft.

6. Reattach Control Arms to Car. Use the OEM Hardware to attach the Upper and the Supplied 1/2"-13 x 3 1/2" Hex Bolts and Nylok Nuts to Install the Lower Control Arms.



Part # 90000894 - A/F/X Tall Upper Ball Joint



Recommended Tools

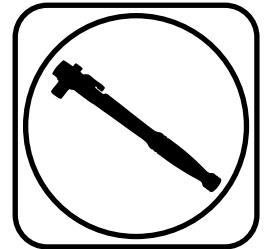

**A/F/X Tall Upper Ball Joint
Installation Instructions**

Table of contents
Page 8..... Ball Joint Installation

Major ComponentsIn the box

Part #	Description	QTY
90000894	A/F/X Tall Upper Ball Joint	2



Getting Started.....

The Tall Upper Ball Joint is used in the StreetGrip Kit to help correct the Camber Gain. The Camber Gain on the OEM Suspension is incorrect and the Tall Ball Joint repositions the Upper Control to help improve the Camber Gain.

The Upper Ball Joint will need to be disconnected from the Spindle. Refer to the Factory Service Manual for Disassembly.



1. If your ball Joints are bolted to the control arms, simply unbolt them. If your car has the original ball Joints, they will be riveted to the control arms. The rivets can be removed by grinding the heads off and driving them out with a hammer and punch.



2. Insert the ball Joint into the control arm from the top side of the control arm with the ball joint pin sticking down. Attach it to the control arm with the hardware supplied with the ball joint. Torque the hardware to 14 ftlbs. Engage the ball joint pin into the spindle and install the supplied castle nut. Torque the castle nut to 50 ftlbs and tighten to align the cotter pin hole. Install the cotter pin through hole and bend the pins to secure.



NOTE: DUE TO THE LONGER SHANK OF THE BALL JOINT, THE BALL JOINT BOOT IS DESIGNED TO SEAL ON THE BALL JOINT SHANK. IT DOES NOT SEAL AGAINST THE SPINDLE. A SEGMENT OF EXPOSED BALL JOINT STEM IS NORMAL.



Part # 11162350/11162351



Recommended Tools

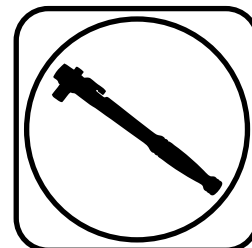

Front CoilSprings Installation Instructions

**1967-69 GM F-Body
1968-74 Chevy Nova
1955-57 Chevy Bel Air**

CoilSpring # 55480700 Small Block / **55518800** Big Block **Installation**

Front dual-rate spring will allow the vehicle to transition small road irregularities via a soft spring rate. When the vehicle compresses the spring far enough (through large bumps or cornering), it transitions to the firmer spring rate to control the bump or body roll. We have worked closely with Hyperco to develop custom dual rates to ensure the best ride possible.

The Front Control Arm Bushings and Upper Ball Joint should be installed before installing spring. The Front Suspension should be assembled with the Lower Ball Joint disconnected from the Spindle.

1. Compress the CoilSpring with an Internal Spring Compressor with the **CLOSE COILS TO THE BOTTOM**.
2. With the OEM Spring Removed, insert the CoilSpring into the Pocket. **SPECIAL ATTENTION NEEDS TO BE PLACED ON THE LOCATION OF THE ENDS OF THE SPRINGS TO MAKE SURE THEY ARE CLOKED CORRECTLY** . The end of the CoilSpring will nest into the receiver area of the Control Arm. If you line up the bottom, the top will be correct.
3. While holding the Spring in place, Slowly Jack the Lower Control Arm up until the Lower Ball Joint can be Engaged into the Spindle. Install the Castle Nut and Torque to 65 ftlbs then tighten as needed to align cotter pin hole. Install Cotter Pin. Once the Ball Joint is tight, remove the Spring Compressor.



Part # 11169120 - 1967-1969 GM F-Body Front Sway Bar



Recommended Tools

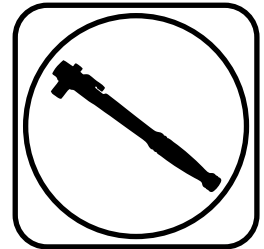

1967-1969 GM F-Body Front Sway Bar Installation Instructions

Table of contents	
Page 11.....	Included Components and Hardware List
Page 12.....	Sway Bar Installation

ATTACH THE SWAYBAR TO THE FRAME BEFORE REINSTALLING THE FRONT SUSPENSION COMPONENTS.

Hardware Torque Specifications	
5/16"-16.....	17 ftlbs

Major ComponentsIn the box

Part #	Description	QTY
90001234	Front Sway Bar	1
90002929	End Link Kit	2
90001344	Billet Bushing Strap	2
70015013	Lined Sway Bar Bushing	2
HARDWARE		
99311030	5/16" -18 x 1" Hex Bolt	4
99313001	5/16" SAE Flat Washer	4
99313005	5/16" Split Lock Washer	4

Getting Started.....

Note: This sway bar kit utilizes a anti-friction lining in the sway bar bushing. The lining allows the sway bar to move freely and quietly in the bushing. No lubrication is required.

1. Jack the vehicle up to a safe working height and support with jack stands. Make sure the jack stands are stable before working under the car.
2. Remove the driver front wheel/tires. It will be required to get the swaybar installed
3. Remove the stock sway bar.



4. Open the sway bar bushing at the split and slip it **OVER** the sway bar. Do this for both bushings



5. Insert the sway bar in the stock location. See below for installation tips.

Installation Tips: It is easier to install if you have the driver wheel/tire removed. Turning the steering wheel to the left also helps. It will require some twisting and turning of the bar to work it through the frame into the stock location. The swaybar needs to end up in the stock location with the ends above the lower control arms.



6.

6. Slip the bushing straps over the sway bar bushings. Line them up with the OEM mounting holes.



8.

7. Install a 5/16" lock washer & 5/16" flat washer on the 5/16" x 1" hex bolts.



8.

8. Torque the mounting hardware to 17 ftlbs.

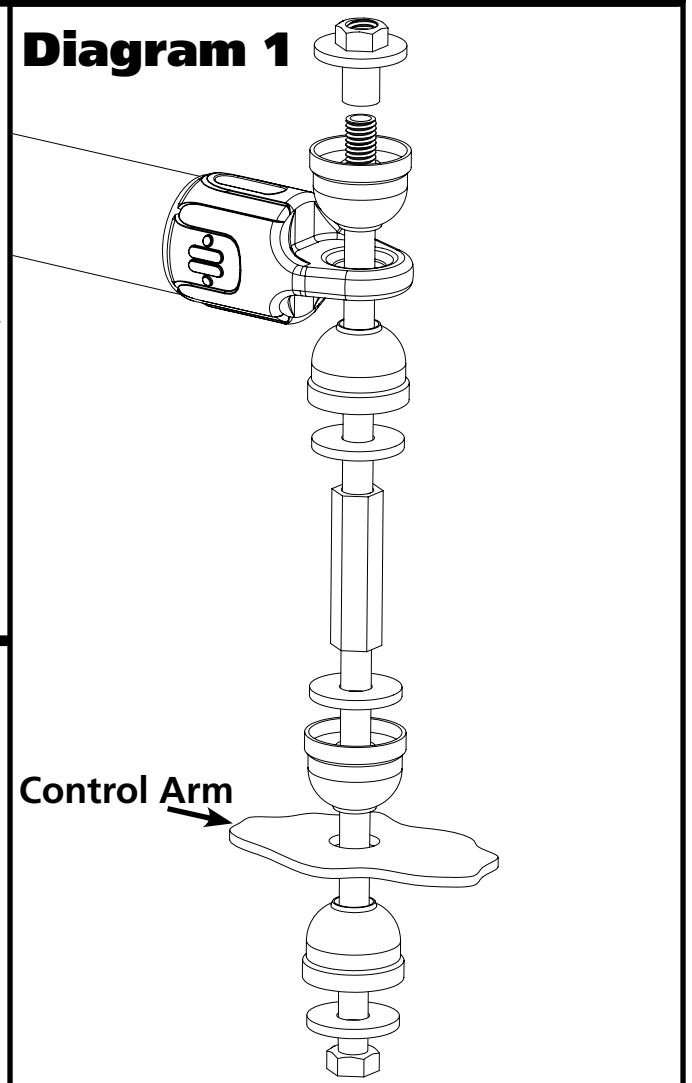

Diagram 1

Control Arm



9.

9. Install the end links using **Diagram 1** as a reference. Install both end links before tightening the end link hardware. Tighten the end link barrel nut until it is flush with the end of the bolt, and then tighten it 2 more complete rounds.



Part # 11164800

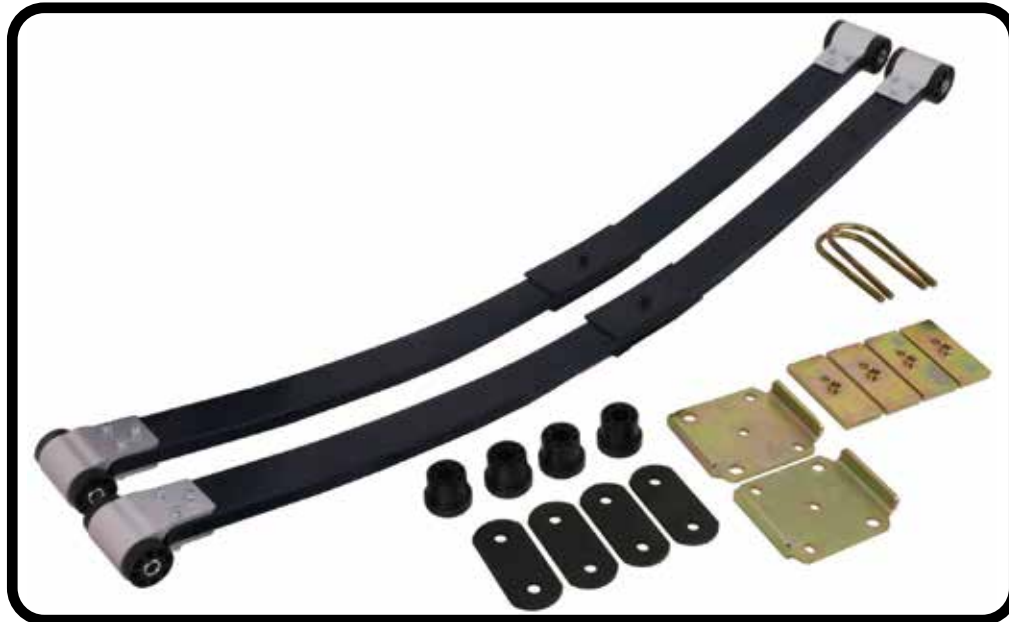

Recommended Tools

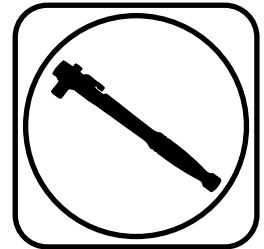

Composite Leaf Springs & Delrin Bushings

Installation Instructions

1967-69 GM F-Body

1968-74 Chevy Nova

Table of contents

Page 2.....	Included Components and Hardware List
Page 3.....	Leaf Spring Installation
Page 4.....	Multi & Mono Leaf Installation
Page 5.....	Mono Leaf Installation
Page 6.....	Mono Leaf & Finalizing Installation

IT IS VERY IMPORTANT THAT NOTHING COMES IN CONTACT WITH THE COMPOSITE LEAF SPRINGS.

THESE COMPOSITE LEAF SPRINGS WILL ACCEPT OEM LEAF SPRING BUSHINGS. THE RIDETECH STREETGRIP KIT HAS THE DELRIN LEAF SPRING BUSHINGS (11165399) PREINSTALLED FOR MAXIMUM PERFORMANCE.



Major ComponentsIn the box

Part #	Description	QTY
90002907	Leaf Spring Blade Assembly w/70012426, 70012427, & 90000526 installed	2
90002497	Leaf Spring Clamping Plates	4
90002526	Mono Leaf Clamping Plate	2
70012428	Delrin Rear Shackle Frame Bushing	4
90000526	Inner Bushing Sleeve	2
90002496	Shackle Plate	4
99436001	7/16"-20 U Bolt	2
99372009	3/8"-16 U-Nut	6
99371050	3/8"-16 x 1 1/2" Conical Body Bolt	6

HARDWARE BAG - Leaf Spring Kit & Mono Leaf

Part #	Description	QTY	Part #	Description	QTY
99501035	1/2"-13 x 5" Hex Bolt GR8	6	99432009	7/16"-20 High Nut	8
99502009	1/2"-13 Nylok Nut GR 8	6	99431020	7/16"-20 x 2 1/2" Hex Bolt GR8	4
99433005	7/16" SAE Flat Washer	8			

Monoleaf & Multileaf Axle Mount

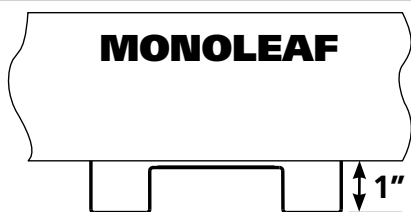

Monoleaf leaf spring pad is approximately 1" tall.

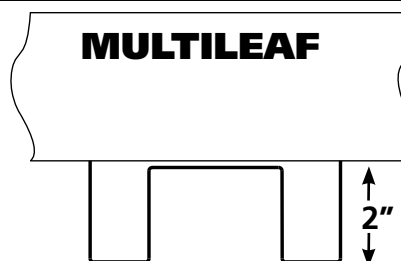

Multileaf leaf spring pad is approximately 2" tall.

Use the above diagrams to help you determine which leaf spring mount is on your car's axle.

Getting Started.....

IT IS VERY IMPORTANT THAT NOTHING COMES IN CONTACT WITH THE LEAF SPRING.

THIS LEAF SPRING KIT WILL WORK WITH MONO LEAF OR MULTI LEAF DIFFERENTIALS, BUT THE INSTALLATION PROCESS VARIES BETWEEN THE TWO. THESE INSTRUCTIONS COVER BOTH SETUPS, BE AWARE THAT YOU ARE DOING THE CORRECT STEPS FOR YOUR DIFFERENTIAL.

1. Jack the car up and support it by the frame rails. You will need to raise and lower the rear differential with a jack to ease installation. With the car supported by the frame, put the jack underneath the rear end housing and raise the jack up just enough to support the differential. Disconnect the bottom of the shock and remove the rear leaf springs. Retain the OEM hardware. The OEM frame bushings will need to be removed and all debris removed from the holes to ease installation of the bushings.

2. The Shackle Plates and Hardware can be used to push the rear bushings into the frame location. Start the bushings into the frame and insert a 1/2"-13 bolt into a shackle plate. Insert the bolt/shackle plate into the bushing and install a second shackle plate on the bolt sticking through the bushing. Install a 1/2"-13 nut and tighten until the bushings bottom out on the frame. Remove the shackle plates and install the inner sleeve.



Leaf Spring Installation

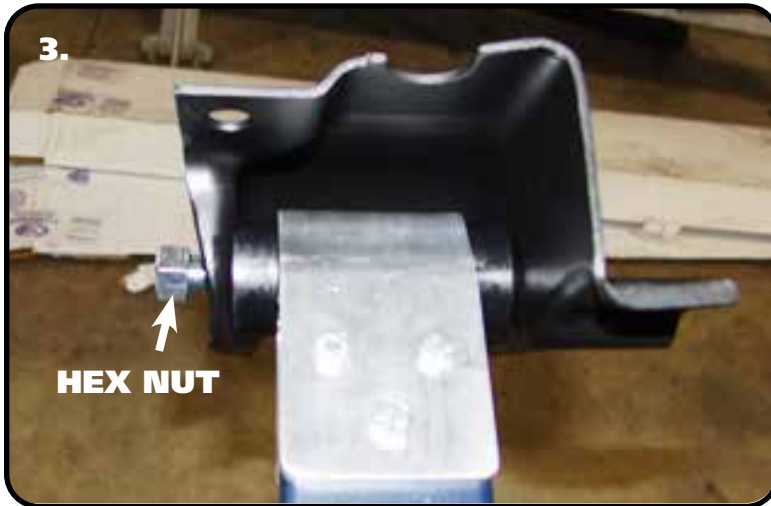

3. Bolt the **LARGE BUSHING END** of the Composite Leaf Spring into the OEM front leaf spring mount using a 1/2"-13 x 5" Hex Bolt and 1/2"-13 Nylok Nut. The Bolt must be installed with the threads pointing to the **OUTSIDE** of the car. Diagram #3 is the correct orientation.

NOTE: Front spring pocket must be removed from car before installing new springs. New Hardware is supplied in kit.

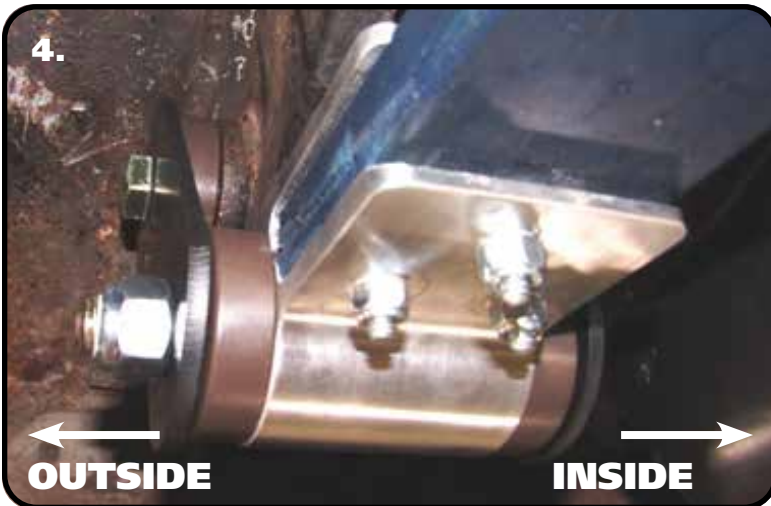

4. Attach the rear of the Composite Leaf Spring to the rear mount. If you are using the Ridetech Delrin Bushings, new Shackles and Hardware is supplied with them. Attach a Shackle Plate to each side of the Frame Bushing using a 1/2"-13 x 5" Bolt (WITH THREADS POINTING TO INSIDE OF CAR) and 1/2"-13 Nylok Nut. Do not tighten. Align the remaining bolt holes in the shackle plates with the sleeve in the rear Leaf Spring bushing. Install a 1/2"-13 x 5" Bolt (WITH THREADS POINTING TO OUTSIDE OF CAR) and 1/2"-13 Nylok Nut. Do Not tighten hardware, it will get tightened later.



5. Swing the Leaf Spring up and attached the front mount to the car using the supplied 3/8"-16 x 1 1/2" Conical Body Bolts and U-Nuts. Tighten Hardware

Note: You may have to jack the rear differential up enough to swing the leaf spring in place.

IF YOU HAVE A MONO LEAF DIFFERENTIAL, SKIP TO STEP 8.



CLAMPING PLATES

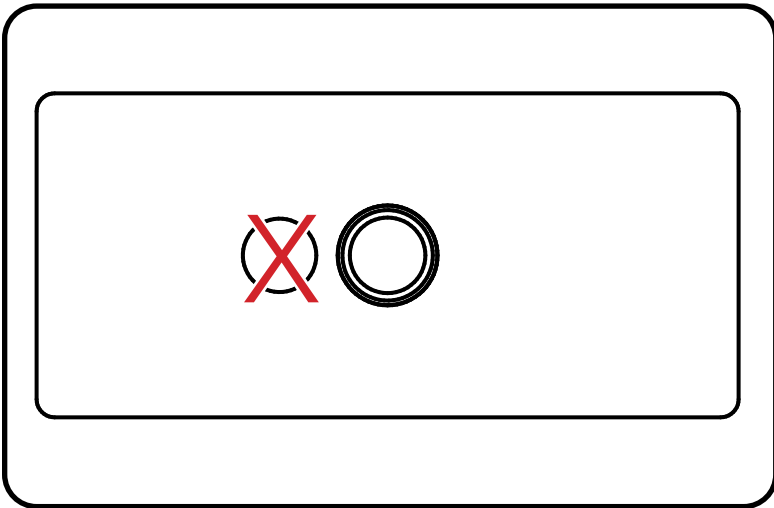

THE LEAF SPRING CLAMPING PLATES IN THIS KIT CONTAINS 2 HOLES. THE CENTER HOLE IS THE ONLY HOLE USED IN THIS INSTALLATION. THE OFFSET HOLE WITH THE "X" OVER IT IN THIS IMAGE WILL **NOT** BE USED.

NOTE: Do not forget to remove the OEM rubber isolators from the mounting plates on the axle. This is necessary to achieve proper clamping of the composite springs.

MULTI LEAF DIFFERENTIAL Installation

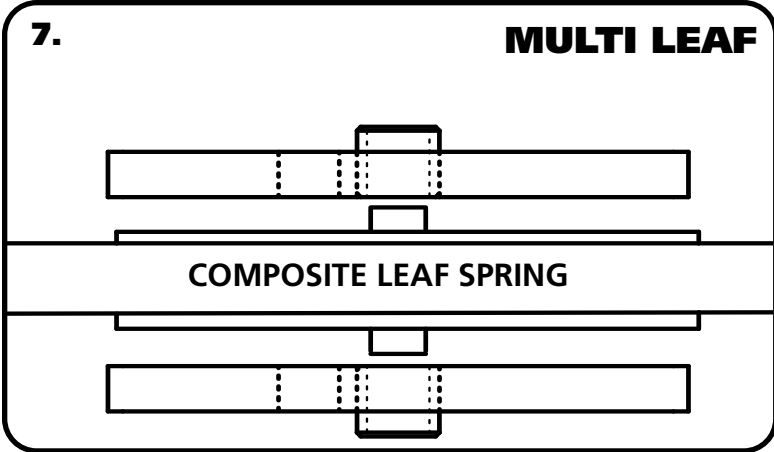

STEPS 7 & 8 ARE FOR MULTI LEAF ONLY!
7. The Composite Leaf Spring has to be clamped in place with the OEM lower plate. A Multi-Leaf car requires a Clamping Plate on the top and bottom of the leaf spring. The top and bottom locating pins need to be inserted into the holes in the Clamping Plates on the FLAT SIDE. The Clamping Plates have a pin on each one of them. They will need to be inserted into the holes on the leaf spring mount and lower plate to correctly position the rear differential.

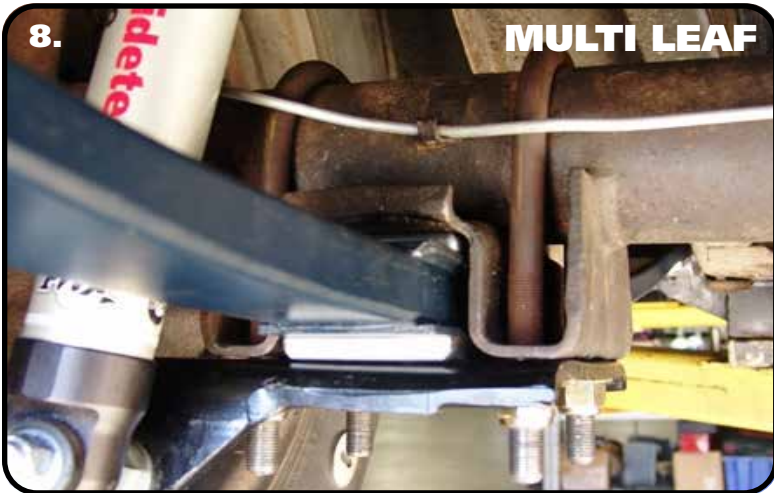

8. Lower the differential onto the Leaf Spring with the top Clamping Plate in place, shown in Diagram "7". Align the top PIN into the HOLE in the OEM leaf spring mount. Install the lower Clamping Plate followed by the OEM lower mount being sure the Pins and Holes are aligned. Install the OEM hardware. Evenly tighten the hardware by tighten in a crisscross fashion. Torque the nuts to 55 ftlbs.

Note: When tightening the mounts, pay attention to the pads on the springs to make sure there is visible compression of the pads. .030" - .060" of compression is needed for the springs to be securely mounted. All of the clamping force needs to be on the spring itself.

SKIP TO STEP #14 TO FINISH THE LEAF SPRING INSTALLATION



MONO LEAF Installation

9.

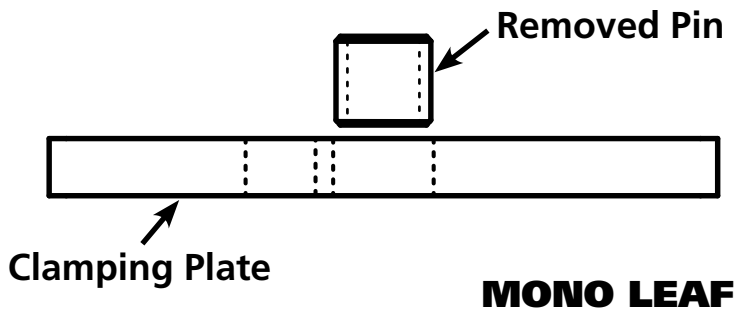

9. The kit contains 4 Clamping Plates that are all the same. For a Mono Leaf installation, the center pin will need to be removed from **2** of the plates. The pin can be knocked out with a hammer and punch.

Diagrams 10, 11, & 12 will be used to aid in the installation of the Clamping Plates on a Mono Leaf Differential.

10.

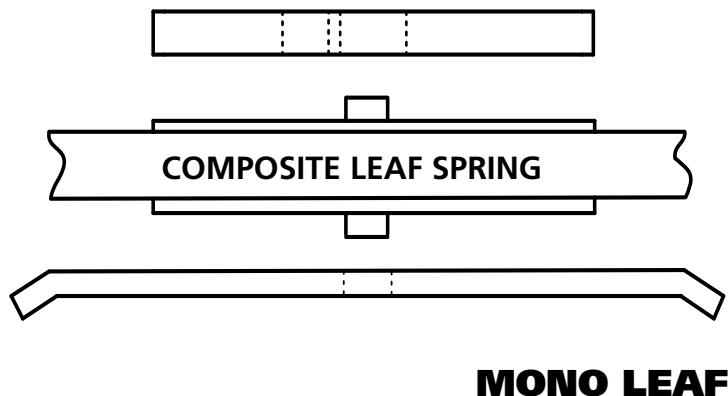

10. The Composite Leaf Spring will be clamped in place with the OEM lower plate. This setup utilizes a Clamping Plate on the top and bottom of the leaf spring. **The Locating Pin on the Composite Leaf Spring needs to be inserted into the holes on the Clamping Plates.** The Clamping Plate with the **Pin REMOVED** is used on the **TOP**. The Locating Pin on the bottom of the leaf spring will need to be inserted into the center hole in the Lower Clamping Plate, this will position the differential correctly.

11.

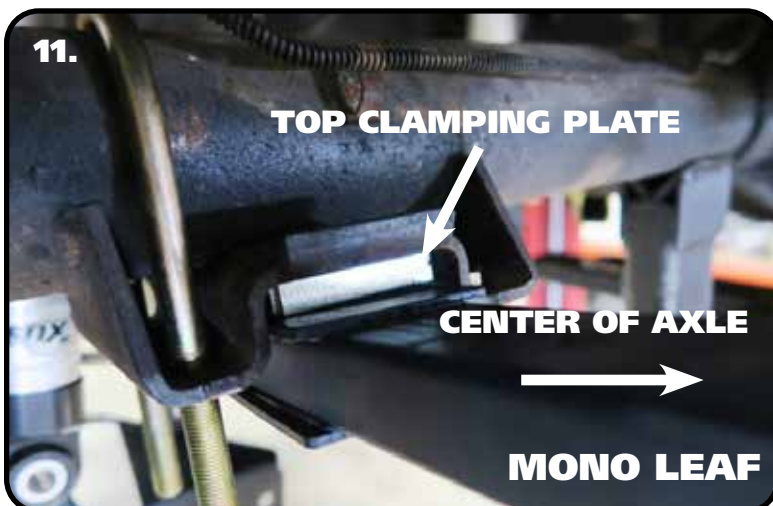

11. Remove the OEM Hardware from the OEM leaf spring mount, it will be replaced with hardware supplied in the kit. The new Hardware includes (1) 7/16 U Bolt, (2) 7/16"-20 x 2 1/2" Hex Bolts, (4) Flat Washers, & (4) 7/16-20 Nylok Nuts per side. The U Bolt will replace the outer OEM hardware, the 7/16" x 2 1/4" bolts replace the inner OEM hardware. Install the U Bolt and Hex Bolts.



MONO LEAF Installation

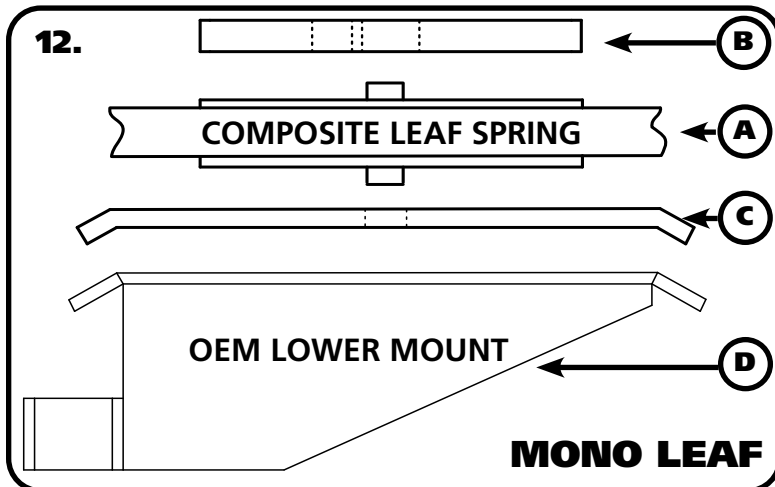

12. Align the top **PIN** into the **HOLE** in the Top Clamping Plate(**B**). Lower the differential onto the Leaf Spring(**A**) with the Top Clamping Plate(**B**) centered on the pin. Install the Lower Clamping Plate(**C**) by sliding it up on the mount hardware. It may be necessary to reposition the differential to get the **BOTTOM** Locating pin in the **HOLE** in the Lower Clamping Plate(**C**). Next, install the OEM lower mount(**D**) being sure the Pins and Holes are aligned and the lower shock mount is in the correct position.

13. Install a 7/16" Flat Washer and 7/16-20 High Nut on each U bolt and Hex Bolt. Evenly tighten the nuts to a Torque of 55ftlbs.

Note: When tightening the mounts, pay attention to the pads on the springs to make sure there is visible compression of the pads. .030" - .060" of compression is needed for the springs to be securely mounted. All of the clamping force needs to be on the spring itself.

Continue to Step 14

Finalizing Installation

14. Tighten the Bushing hardware, torquing it to 75 ftlbs. The Delrin Bushings will not bind, so it isn't necessary to have the car at ride height. If using OEM style rubber bushings, the car will need to be on the ground at ride height before tighten the bushing hardware.

15. Install the Ridetech HQ Series shocks. Refer to the shock instructions.

16. DOUBLE CHECK TO MAKE SURE NOTHING IS COMING INTO CONTACT WITH THE LEAF SPRING.



Front & Rear HQ Series Shocks



Recommended Tools

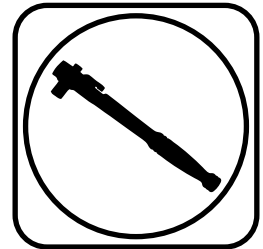

Front & Rear HQ Series Installation Instructions

Table of contents

Page	19-20.....	Rear Shock Installation
Page	20-21.....	Front Shock Installation
Page	22.....	Shock Adjustment

Rear - Part # 22189842 - 7.55" HQ Series Shocks

Major ComponentsIn the box

Part #	Description	QTY
986-10-049	7.55" Stroke Shock	2
70011141	Bushing Support Washer	4
70011140	Stem Bushing	4
99372006	3/8"-24 Thin Jam Nut	4
90002102	1/2" ID Shock Sleeve	2
70011194	7/16" ID Shock Sleeve	2
90002103	5/8" ID Shock Sleeve (Installed in Shock)	2
90001619	Cantilever Pin	2
90000471	Cantilever Pin Spacer	2
70011138	3/4" ID Shock Bushing	2



Rear - Part # 22189842 - 7.55" HQ Series Shocks

The Rear Shocks will be installed in conjunction with the Rear Leaf Springs.

1. With the OEM shock removed, attached the stud top to the OEM mount using Step #1 on Page 21 for proper stud top assembly procedure.

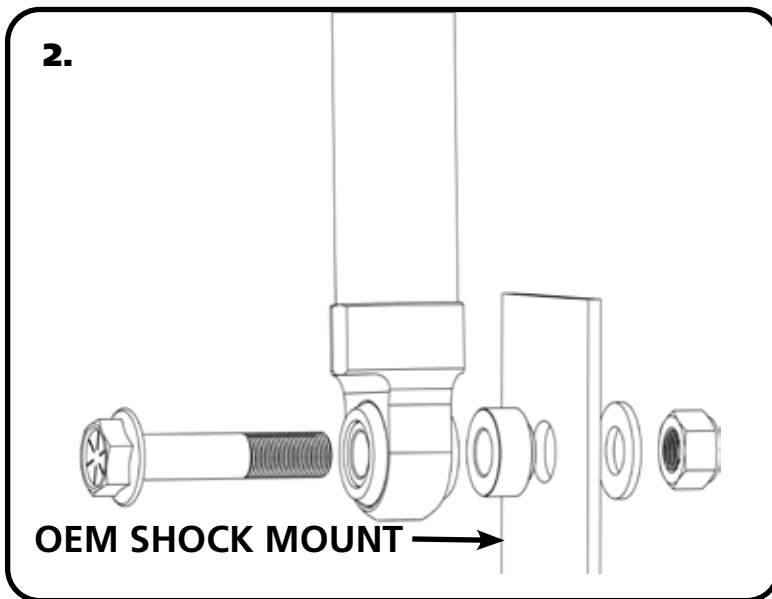

2. The Lower Shock is Bolted to the Lower OEM Mount using the supplied Bolt Kit. Insert the 1/2"-20 x 3" flanged head bolt into the Shock Bushing. Next, Slide the Aluminum Spacer onto the threads of the bolt. With the LeafSprings in place, Jack the Rear Differential up until the Shocks can be Bolted in place. Insert the Assembly into the OEM Shock Hole. Install the supplied Lock Washer and Hex Nut onto the Threads and tighten. If it uses a 7/16" or 5/8" thru bolt, install the 7/16" or 5/8" Bushing Sleeve in the shock and use the OEM lower hardware to attach the lower.

Front- Part #22149846 - 4.75" Stroke HQ Series Shocks

Major ComponentsIn the box

Part #	Description	QTY
986-10-042	4.75" Stroke Shock	2
70011139	5/8" ID Shock Bushing (Installed in Shock)	2
90002069	Standard Trunnion (Installed in Shock)	2
70011141	Bushing Support Washer	4
70011140	Stem Bushing	4
99372006	3/8"-24 Thin Jam Nut	4



Front Shock Installation

Due to manufacturing tolerances it may be necessary to clearance the Control Arm to get the Shock through the Control Arm opening.

Before installing the Shocks, the Control Arm Bushings, Upper Ball Joint, and CoilSprings should be installed.

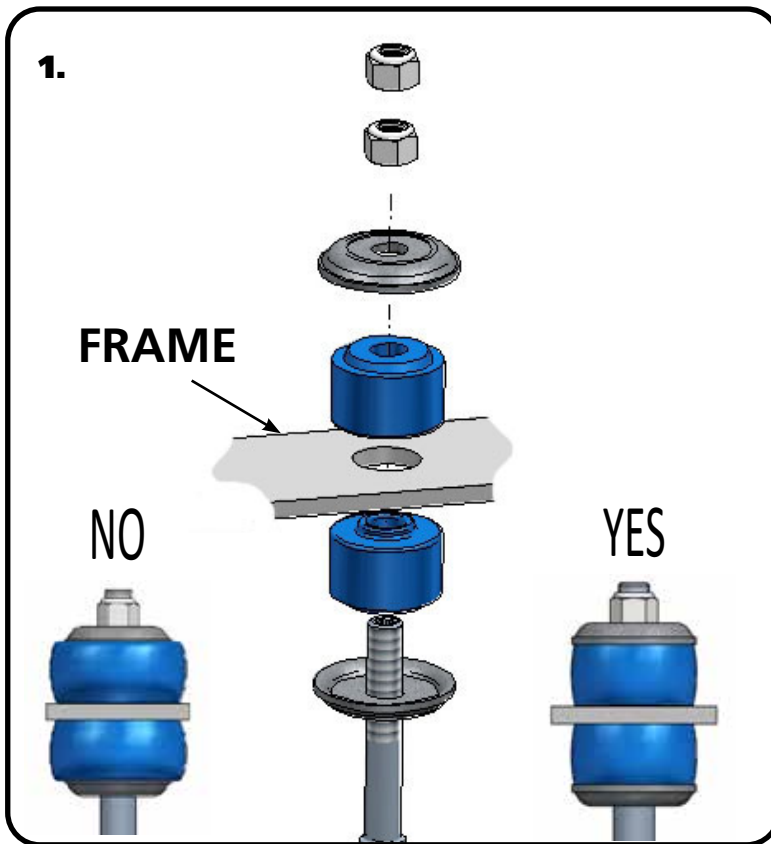

1. With the OEM shock removed, install the Ridetech shock. Remove the adjuster knob by loosening the set screw using the supplied Hex Key. Install a Bushing Support Washer on to the shock shaft followed by a Shock Stem Bushing. Insert the assembly through the factory shock hole in the frame. With the shock stud sticking through the frame, install a Shock Stem Bushing on to the shock stud followed with a Bushing Support Washer. Install a 3/8"-24 Thin Jam nut onto the threads and tighten to 35 inlbs. The Bushing should be tight, but not to the point that the bushing is bulging past the Support Washer. Install the 2nd 3/8-24 Thin Jam nut and tighten it against the first nut. Reinstall the Adjuster Knob, align the set screw with the FLAT side of the adjuster shaft that is sticking out of the top of the shock shaft.

NOTE: It may be necessary to remove the OEM Speed Nuts from the Control Arm to allow room for the Shock to slide through the opening in the Control Arm. The Speed Nuts can be reinstalled after the Shock is in position.

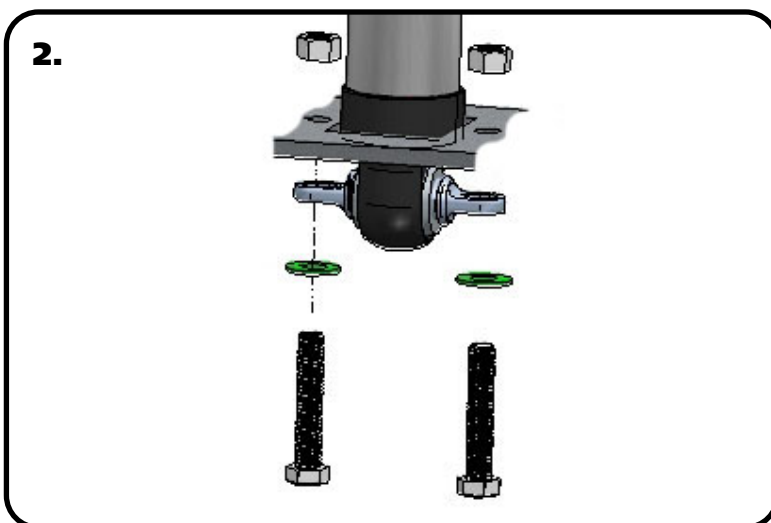

2. Attach the Trunnion to the OEM Control arm using the OEM hardware. It may be necessary to rotate the Trunnion to get it in the correct position. This can be done by sticking a screwdriver in one of the slots and spinning the trunnion in the shock bushing.



Shock Adjustment

Shock adjustment 101- Single Adjustable

Rebound Adjustment:

How to adjust your new shocks

The rebound adjustment knob is located on the top of the shock absorber protruding from the eyelet or stud top. You must first begin at the ZERO setting, then set the shock to a street setting of 12 or handling setting of 8.



-Begin with the shocks adjusted to the ZERO rebound position (full stiff). Do this by rotating the rebound adjuster knob clockwise until it stops.

-Now turn the rebound adjuster knob counter clockwise 12 clicks. This sets the shock at 12 for a street setting. If you are after a handling setting only go 8 clicks.

Take the vehicle for a test drive.



-if you are satisfied with the ride quality, do not do anything, you are set!

-if the vehicle is too soft increase the damping effect by rotating the rebound knob clockwise 3 additional clicks.

-If the vehicle is too stiff rotate the rebound adjustment knob counter clock wise 2 clicks and you are set!

Take the vehicle for another test drive and repeat the above steps until the ride quality is satisfactory.

Note:

One end of the vehicle will likely reach the desired setting before the other end. If this happens stop adjusting the satisfied end and keep adjusting the unsatisfied end until the overall ride quality is satisfactory.