

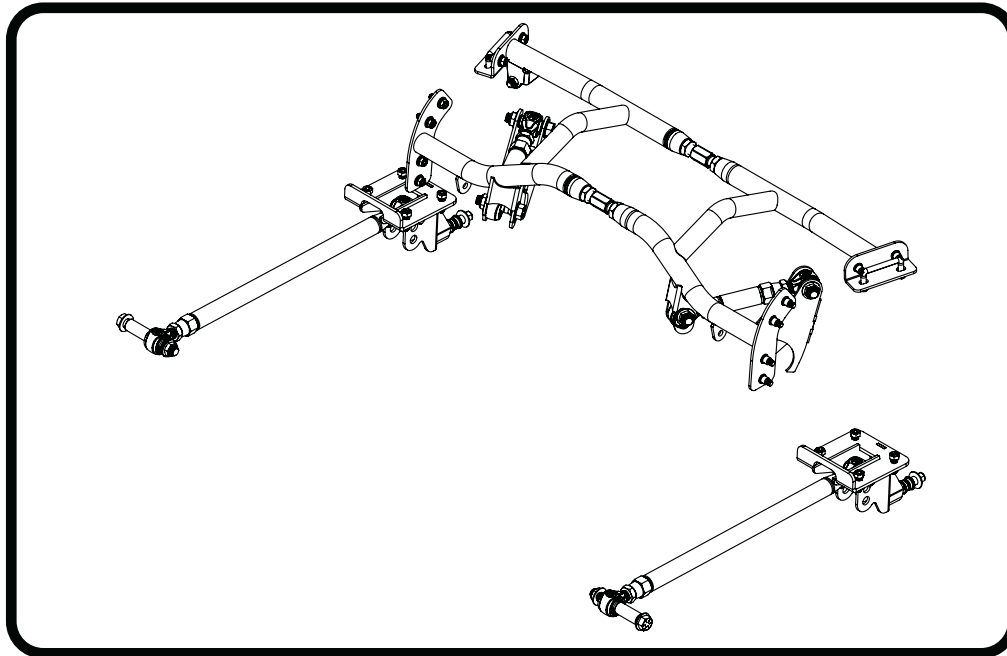

Part # 11177187 -1970-1981 GM "F" Body Rear Bolt-in 4 Link

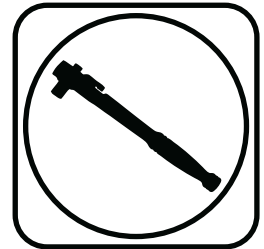

Recommended Tools



1970-1981 GM "F" Body Rear Bolt-in 4-Link Installation Instructions

Table of contents

Page 2-3.....	Included Components
Page 4.....	Hardware List & Getting Started
Page 5-6.....	Disassembly
Page 6-8.....	Cradle Assembly
Page 9.....	R-Joint Bar Assembly
Page 10-15.....	Cradle Installation
Page 16-17.....	Installing Lower 4 Link Bars
Page 17.....	Installing Lower Axle Mounts
Page 18.....	Installing Lower Shock Mount
Page 18-19	Installing Lower 4 Link Bars
Page 20	Setting Pinion Angle
Page 21-23.....	Upper Bar Tab Installation
Page 23-24.....	Installing Upper 4 Link Bars
Page 25.....	Installing Lower Shock Stud
Page 26.....	Installing ShockWaves/CoilOvers
Page 27.....	Anti Squat Adjustment





Major ComponentsIn the box

Item #	Part #	Description	QTY
1	90003497	70-81 F-Body Rear Cradle - Driver	1
2	90003498	70-81 F-Body Rear Cradle - Passenger	1
3	70015662	Cradle Threaded Adjuster	2
4	70016351	Upper Axle Tab - Inner	2
5	70016352	Upper Axle Tab - Outer	2
6	70016353	Upper Axle Tab - Backer	2
7	90001318	R-Joint 3/4-16 RH x 5/8 Bolt	4
8	90001319	R-Joint 3/4-16 LH x 5/8 Bolt	4
9	90003503	Lower Axle Mount	2
10	70013334	R-Joint Spacer - 5/8" ID x .620"	14
11	70013537	5/8 R Joint Spacer .625 ID x 2.843"	2
12	90003499	Lower 4-Link Bar	2
13	90002815	Upper 4-Link Bar	2
14	90001624	Aluminum Lower Shock Mount	2
15	70002825	Lower Shock Stud	2
16	90002067	Lower Shock Spacers - .625" I.D. x .450"	4
17	90002043	Upper Shock Spacers - .500" ID x .365"	4
18	90002285	Square U-Bolt	2
	85000008	3/8" Riv-Nut Installation Tool	1
	70010694	Bar Tab Setting Jig	2
	99371050	3/8-16 X 1 1/2 HX 1.12 CONI	6
	99372009	3/8"-16 U-Nuts - .090 -.20 Panel Thickness	6
	99010218	Hardware Kit: 70-81 F-Body 4-Link	1



Major ComponentsIn the box

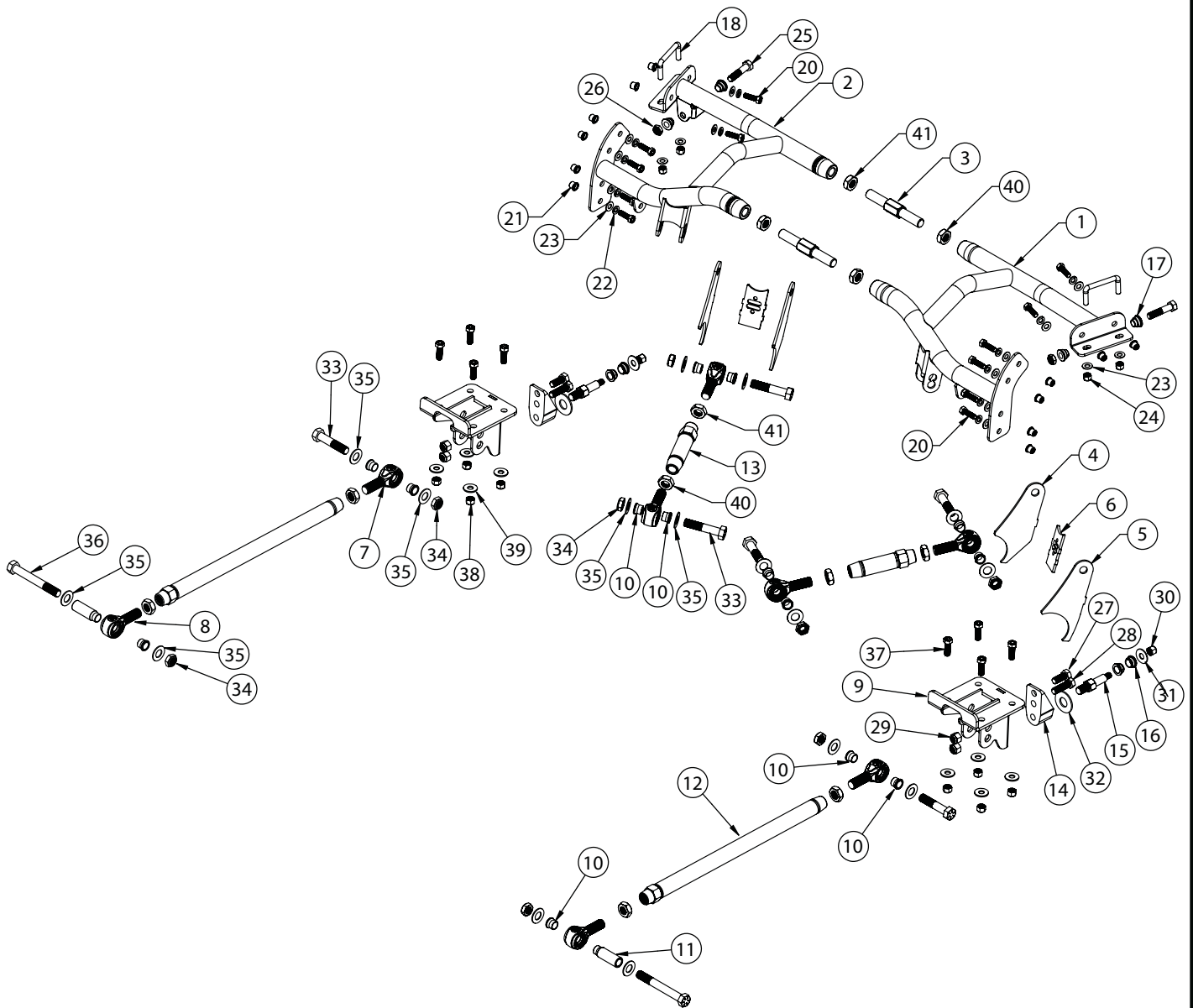

New R-Joints will be quite stiff (75-90 in/lbs breakaway torque) until they "break in" after a few miles of use. After the break in period they will move much more freely. Because the composite bearing race contains self lubricating ingredients, no additional lubrication is needed or desired. Any additional lubrication will only serve to attract more dirt and debris to the R-Joint and actually shorten its life.



Hardware ListIn the box (Kit# 99010218)

The Hardware Kit contains bags to help aid in selecting the correct hardware for the component being installed. The hardware list shows how the hardware is bagged.

Item #	QTY	Part Number	Description	Item #	QTY	Part Number	Description
CRADLE TO FRAME				UPPER 4 LINK BARS			
19	1	85000007	17/32" Drill Bit	33	4	99621004	5/8"-18 x 3" Gr. 8 Bolt
20	12	99371005	3/8"-16 x 1 1/4" Hex Bolt	34	4	99622006	5/8"-18 Thin Nylok Nut
21	12	99372007	3/8"-16 Riv-Nut	35	8	99623001	5/8" SAE Flat Washer Gr. 8
22	12	99373006	3/8" Split Lock Washer		1	90002276	Anti-Seize
23	12	99373002	3/8" SAE Flat Washer GR 8	LOWER 4 LINK BARS			
	1	90002276	Anti-Seize	33	2	99621004	5/8"-18 x 3" Gr. 8 Bolt
CRADLE U-BOLTS				34	4	99622006	5/8"-18 Thin Nylok Nut
23	4	99373002	3/8" SAE Flat Washer GR 8	35	8	99623001	5/8" SAE Flat Washer Gr. 8
24	4	99372001	3/8"-16 Nylok Nut	36	2	99621007	5/8"-18 x 5" Gr. 8 Bolt
UPPER SHOCK MOUNTING					1	90002276	Anti-Seize
25	2	99501010	1/2"-20 x 2 1/4" Gr. 8 Bolt	LOWER BAR MOUNT TO AXLE			
26	2	99502003	1/2"-20 Thin Nylok Nut	37	8	99431006	7/16"-20 x 1 1/4" Hex Bolt
LOWER SHOCK MOUNT				38	8	99432007	7/16"- 20 Nylok Nut
27	2	99501007	1/2"-20 x 1 1/4" Hex Bolt	39	8	99433002	7/16" SAE Flat washer
28	2	99501009	1/2"-20 x 1 3/4" Hex Bolt	RIGHT HAND & LEFT HAND JAM NUTS			
29	4	99502002	1/2"-20 Nylok Nut	40	6	99752004	3/4"-16 Jam Nut RH
SHOCK STUD				41	6	99752006	3/4"-16 Jam Nut LH
30	2	99432002	7/16"-20 Nylok Nut	BAR SETTING JIG			
31	2	99433002	7/16" SAE Flat Washer		2	99371001	3/8"-16 x 3/4" Hex Bolt
32	2	99623004	5/8" SAE Flat Washer		2	99372004	3/8"-16 Hex Nut

Getting Started.....

Congratulations on your purchase of the Ridetech Rear 4-link System. This system has been designed to give your Camaro excellent handling along with a lifetime of enjoyment. This kit replaces the Leaf Springs, this allows the 4-Link to locate the rearend and the CoilOvers/ShockWaves to support the car. This allows each to be optimized for the best performance.

Note: These system is designed for use with the Ridetech Shockwaves or CoilOvers and the Ridetech Rear Sway Bar. **The factory shocks and springs will not fit this setup.**

1. Raise the vehicle to a safe and comfortable working height. Use jack stands to support the vehicle with the suspension hanging freely.



Disassembly

2. Support the axle and remove the leaf springs, shocks, and tail pipes. If your car is equipped with a rear sway bar, it will also need to be removed. Refer to the factory service manual for proper disassembly procedures. **The rear brake line will need to be detached from the body. You will need to bleed the rear brakes after the installation is complete. You may need to redo the brake lines that are on the differential.**

The following steps show the removal of brackets, these can vary depending on the year of the car. Some years do NOT have some of the brackets shown. If your car doesn't have the particular bracket shown in a step, skip to the next step.



3. Cut the corner braces off that are located above the axle where the frame rail drops down. **Depending on the year of your car, it may not be equipped with these braces.** These can be removed by drilling the spot welds or cutting them off flush with the tabs, but we recommend drilling the spot welds.



4. Drilling the spot welds of the tabs will ensure a tighter fit of the cradle.



Disassembly & Cradle Assembly



5. If your car has this style of exhaust bracket behind the axle, they will need to be cut off. Again, this can be done by drilling the spot welds or cutting off flush with the tabs. The early cars have a different style of mount that doesn't need to be cut off.



6. Unbolt the pinion snubber and remove it.



7. The upper cradle is adjustable to compensate for different frame rail widths found on the 70-81 Camaro. The cradle will need to be assembled before installing it in the car.



Cradle Assembly



8. The center adjuster has Right Hand Threads on one side, Left Hand Threads on the other side. This allows the cradle to be adjusted in the car. Install the jam nuts on the adjusters.



9. Apply anti-seize to the end of the threads of the adjusters. We run about a 3/8" strip on them.



10. The driver side of the cradle is Left Hand Threads, the passenger side is Right Hand Threads. Start the adjusters into opposite sides of the cradle, inserting them in approximately 2 revolutions.



Cradle Assembly



11. The gap between the cradle halves is 1/4" shorter on the front tube than the rear tube. This allows the adjusters to be started at different times. Start the front adjuster into the opposite half of the cradle. Thread it in until the second adjuster is starting to hit the end of the threads of the thread bung.



12. Start the 2nd adjuster into the cradle. You may have to loosen or tighten the 1st adjuster to get the 2nd started.



13. With both adjusters started. Thread them in evenly until the cradle is just narrow enough to fit in your car. The gaps between the front and rear adjusters should be approximately 1/4" difference with the gap of the front tube being the lesser of the two. If an adjuster starts getting tight to turn, switch to the opposite adjuster until it starts getting tight. Go back and forth between the 2 to achieve a width that will fit your car.



R-Joint Bar Assembly

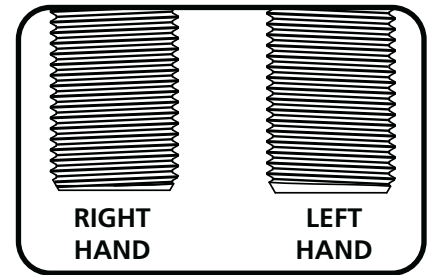
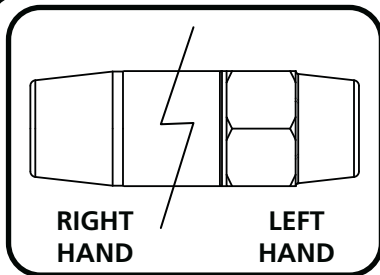

THE 4-LINK BARS, R-JOINTS, AND JAM NUTS HAVE RIGHT HAND AND LEFT HAND THREADS. THIS ALLOWS THE BAR TO BE ADJUSTED WITHOUT REMOVING IT. THE HEX END OF THE BAR IS LEFT HAND THREAD. THE LEFT HAND JAM NUT HAS AN COUNTER-CLOCKWISE ARROW STAMPED INTO IT. IMAGE 3 WILL HELP YOU DETERMINE THE THREADS OF THE R-JOINTS.

14a. Component List:

1. 4-Link Bar
2. Right Hand Thread R-joint
3. Right Hand Thread Jam Nut
4. Left Hand Thread R-Joint
5. Left Hand Thread Jam Nut

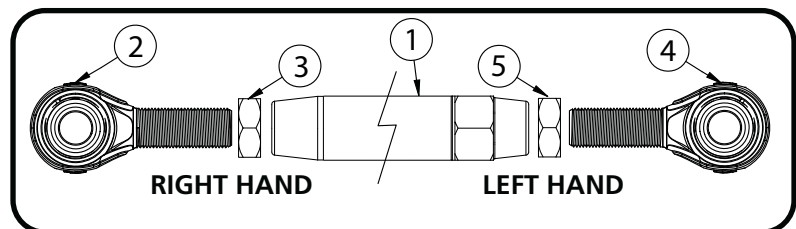

14b. Thread the jam nuts onto the threaded shank of the r-joints. Thread the nuts all the way on to the r-joint.

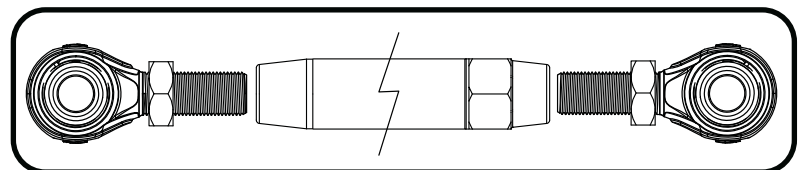

14c. Apply *anti-seize* to the threads of the r-joint. This will prevent the threads from galling.



14d. Thread the r-joints into the 4-link bar. Thread them in evenly until you achieve the correct center to center length.

Upper Bar Length: 9 1/4"

Lower Bar Length: 24 1/4"

Nominal R-Joint Threads Exposed: 1/4"

Maximum R-Joint Threads Exposed: 5/8"

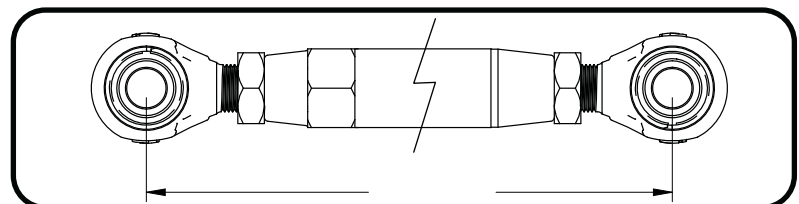

14e. After getting one bar length set, you can put a 5/8" bolt through the r-joints to simplify setting the next bar. Adjust the bar length of the 2nd bar until it will slip on and off the bolts. Torque the jam nuts 65-75 ft-lbs using an 1 1/8" crows foot on a torque wrench.





Cradle Installation



NOTE: Steps 15-18 cover the installation of the cradle. The front flanges of the cradle are parallel with each other, the rear mounts are tapered. With the front mounts fitting snug against the inside frame rails, the taper of the rear mounts will help position the cradle in the car.

TIP: You can use a tape measure to get the cradle close before putting it in the car. Measure the inside width of the frame rails in the area where the front mounts will be positioned. Evenly adjust the center adjusters to get the front mounts of the cradle close to this width measurement.

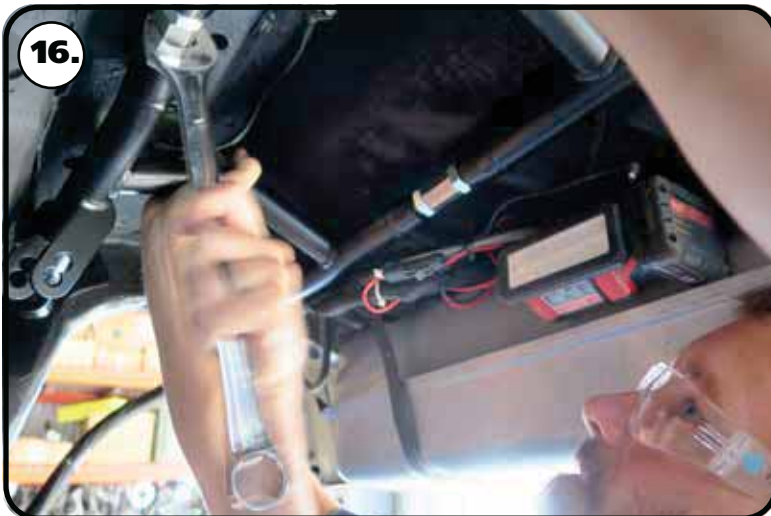

15. Insert the cradle into the car, but don't slide it all the way forward yet. Fine tune the adjusters to get the front flanges snug in the frame rails. Setting the front width will get the rear cradle mounts fairly close to the correct width too. When you get the front snug, push the cradle forward until the rear mounts are snug in the frame. The vertical surface of the rear mount will be fairly snug against the frame rails with the horizontal tabs sitting against the bottom of the frame rail.

NOTE: It is not uncommon for the front upper bar mounts to touch the floor pan.



16 & 17. Adjust the center adjusters evenly until the cradle gets tight against the frame. You will need to adjust the front and rear evenly until it fits tight. Again, the horizontal tab on the rear section of the cradle will fit against the bottom of the frame and the vertical surface should be snug against the frame rails.

NOTE: You will need to alternate between the adjusters to get them adjusted out evenly.



Cradle Installation



18. Image 18 shows the cradle in place. When it is snug against the frame, it will hold in place by itself.



19a. Use the frame plates as a template to drill the holes in the bottom of the frame rails. Use a 7/16" drill bit to drill the holes. Drill the slotted hole in the center of the slots.



19b. It might be necessary to elongate the holes a little to get the u-bolt inserted.



Cradle Installation



20. Feed one end of the u-bolt through the round hole of the pair of holes, using the other end of the u-bolt as a handle. You need to get the end of the u-bolt that you are using as a handle fed in until it is past the 90 degree bend to be able to drop the other end through the drilled hole. If the u-bolt will not line up with the drilled holes, it may be necessary to slot the frame hole in the slotted hole of the frame mount.



21. The other leg of the u-bolt needs to drop through the opposite hole of the hole you are inserting the u-bolt in.



22. Install (1) 3/8" flat washer and (1) 3/8"-16 nylok nut onto each stud sticking through the cradle. Do not tighten them until all washers and nuts are installed. Tighten each leg of the u-bolt evenly. Torque to 30 ftlbs. Do this for all (4) u-bolts..



Riv-nut® Installation & Specs

1. Drill Hole in Frame using the SUPPLIED DRILL BIT keeping the Drill square with the metal.

2. We recommend installing (2) 3/8" Flat Washers between the bolt head and the lower anvil of the installation tool. Thread a Riv-nut® onto the supplied Tool. Thread the Riv-nut all the way onto the Tool until it stops.

3. Insert the Tool and Riv-nut® into the drilled hole 90° to the Frame Rail.

4. The Tool requires (1) 9/16" & (1) 5/8" Wrenches to use. A Ratchet can be used on the top of the Tool.

KEEP THE TOOL AND RIV-NUT 90° TO THE SURFACE WHILE TIGHTENING

5. Put a 5/8" Wrench on the Lower Hex of the tool. Use a 9/16" Wrench or Ratchet on the Top hex to Tighten.

6. Hold the Wrench in one position and turn the TOP HEX CLOCKWISE to engage the Riv-nut®. Keep Turning the TOP WRENCH until you feel a positive stop and you can't turn the TOP WRENCH anymore.

7. Break the Tool loose by turning the TOP HEX counterclockwise and thread the Tool out of the Riv-nut®

THE DATA BELOW ILLUSTRATES THE STRENGTH OF THE RIV-NUT®

RIVNUT® Fastener Engineering Data

Upset Load (lbs.)		
RIVNUT * Size	Steel	
	Min. Grip	Max. Grip
3/8-16	4965	5325

Fig. 1

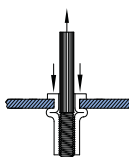

Ultimate thread strength (lbs.)		
RIVNUT * Size	Steel	
	Min. Grip	Max. Grip
3/8-16	11500	10450

Fig. 2

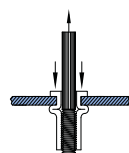

Ultimate tensile strength (lbs.)	
RIVNUT * Size	Steel
3/8-16	3900

Fig. 3

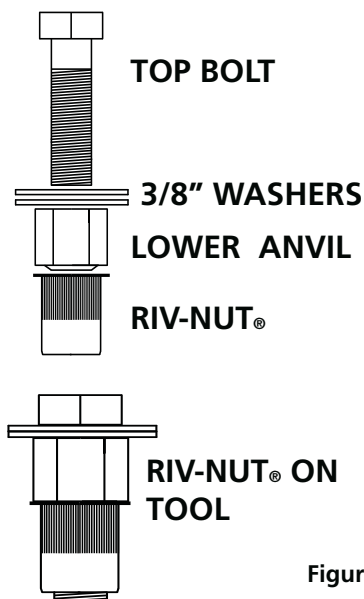
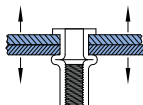

Figure 2

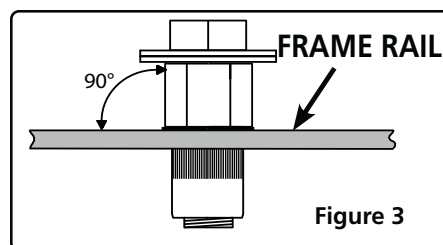

Figure 3

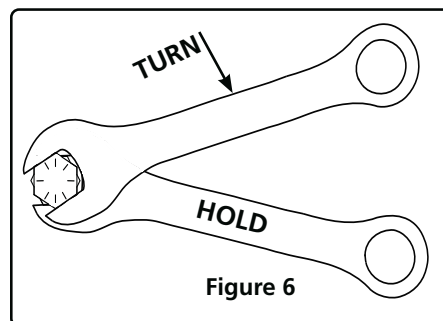

Figure 6

**Single Shear Strength 3/8" Grade 5 Bolt
3,975.8 lbs**



Cradle Installation



23. Mark the holes in the frame for the vertical mounting plates. There are 4 holes in the front plate, 2 holes in the rear plate. Do this for both sides. The cradle will now need to be removed to install the Riv-nuts.



24. The holes for the Riv-nuts NEED to be drilled with the supplied 17/32" drill bit. We suggest drilling the holes with a smaller drill bit first to make it easier to drill with the 17/32" drill bit. Drill all (12) holes in the sides of the frame rails.



25. Install the Riv-nuts in the sides of the frame rails. **Refer to the Riv-nut installation instructions on PAGE 13 for proper Riv-nut installation.** Image 25 illustrates a Riv-nut being installed. Install all (12) Riv-nuts in the frame rails.



Cradle Installation



26. Reinstall the cradle in the car. Reinstall the 3/8" hardware on the u-bolts. Do not tighten them until all washers and nuts are installed. Tighten each leg of the u-bolt evenly. Torque to 30 ftlbs. Do this for all (4) u-bolts.



27. Install a 3/8" split lock washer, and a 3/8" flat washer on each of (16) 3/8"-16 x 1 1/4" hex bolts. Thread a bolt/washer in to each of the Riv-nuts installed in the frame rails. Install all 12 bolts/washers before tightening any of the bolts. Torque the bolts to 23 ftlbs.



28. Tighten the adjuster jam nuts against the tubes of the cradle.



Installing Lower Bars



29. Drill the front leaf spring mounting holes to 5/8".



30. Check the length of the lower bar; it should be 24 1/4" center to center. The R-joint setup is designed to be offset to the inside of the car. The R-joint uses a .620" spacer (70013334) on the inside with a 2.593" long spacer (70013537) on the outside. Insert the small OD of the spacer into the r-joint center ball. Push the spacers in until they bottom out in the center ball.



31. Align the r-joint/spacers with the 5/8" hole. Install a 5/8" flat washer on a 5/8"-18 x 5" hex bolt. Install the bolt/washer in the aligned holes. **The bolt needs to be installed in the same orientation as Image 31.**



Installing Lower Bars & Axle Mount



32. Install a 5/8" flat washer and 5/8"-18 thin nylok nut on the threads of the bolt. Tighten the bolt/nut enough to eliminate any gaps.



33. Attach the lower bar/mount assembly to the car. New 3/18"-16 u-nuts and 3/8-16" x 1 1/2" conical body Bolts are supplied in the kit. Install the u-nuts in place of the OEM u-nuts. Hold the assembly in place lining up the holes with the u-nuts. There is a tab bent up on the mount that indexes into a hole in the body. Make sure the tab is indexed into the alignment hole. Torque the mounting bolts to 30 ft-lbs.



34. The lower axle bracket will be fastened to the leaf spring pad using the factory T-bolts/U-bolts or the supplied 7/16"-20 x 1 1/4" hex bolts. Align the mounting holes of the axle mount with the hardware sticking through the OEM leaf spring mount. Install a 7/16" flat washer & 7/16"-20 nylok nut on the threads sticking through the axle mount. Torque the nuts to 55 ft-lbs. Install both axle mounts.



Installing Lower Shock Mount & Lower Bars



35. The lower shock mount attaches with (1) 1/2"-20 x 1 1/4" hex bolt, (1) 1/2"-20 x 1 3/4" hex bolt, & (2) 1/2"-20 nylok nuts. The lower mount gets attached to the 2nd and 3rd hole up from the bottom of the axle mount. When the shock mount is installed correctly, the bottom of the lower shock mount is 1/8" below the bottom of the axle mount.



36. Insert the bolts through the aluminum shock mount with the 1 1/4" long bolt in the top bolt, 1 3/4" in the bottom hole. Insert the bolts through the axle mount and install the nylok nuts on the threads sticking through. Repeat on both sides and torque the bolts/nuts to 75 ft-lbs.



37. The R-joint uses a .620" spacer (70013334) on each side. Insert the small OD of the spacer into the r-joint center ball. Push the spacers in until they bottom out in the center ball.



Installing Lower Bars



38. Align the R-joint with the **TOP** hole of the axle mount. Install a 5/8" flat washer on a 5/8"-18 x 3" hex bolt.



39. Insert the bolt/washer through the axle mount/bar.



40. Install a 5/8" flat washer and 5/8"-16 thin nylok nut on the threads of the bolt. Do this for both sides. Tighten the bolt/nut enough to eliminate any gaps.



Setting Pinion Angle

READ PAGES 20-23 ON SETTING PINION ANGLES, UPPER BAR TAB JIG INSTALLATION, & SETTING RIDE HEIGHT.

How do you set the pinion angle? On a single-piece shaft you want to set it up where a line drawn through the center of the engine crankshaft or output shaft of the transmission and a line drawn through the center of the pinion are parallel to each other but not the same line.

Your transmission angle should be around 3 degrees down in the rear. If it is more or less than 3 degrees, you might want to consider changing it. Too little angle on the transmission reduces the amount of oil getting to the rear bushing. Too much transmission angle will increase the working angles of the u-joints which will increase the wear. With the transmission at 3 degrees down in the rear, you will want to set the pinion 3 degrees up in the front.

A simple way to do this is to place a digital angle finder or dial level on the front face of the lower engine pulley or harmonic balancer. This will give you a reading that is 90 degrees to the crank or output shaft unless you have real problems with your balancer. At the other end, you can place the same level or angle finder against the front face of the pinion yoke that is also at 90 degrees to the centerline. If you rotate the yoke up or down so both angles match, you have perfect alignment.

Road testing will tell you if you have it right. If you accelerate and you get or increase a vibration, then the pinion yoke is too HIGH. Rotate it downward in small increments of a degree or two until the problem goes away. If you get or increase a vibration when decelerating, then the pinion yoke is too LOW. Rotate it upward to correct it.

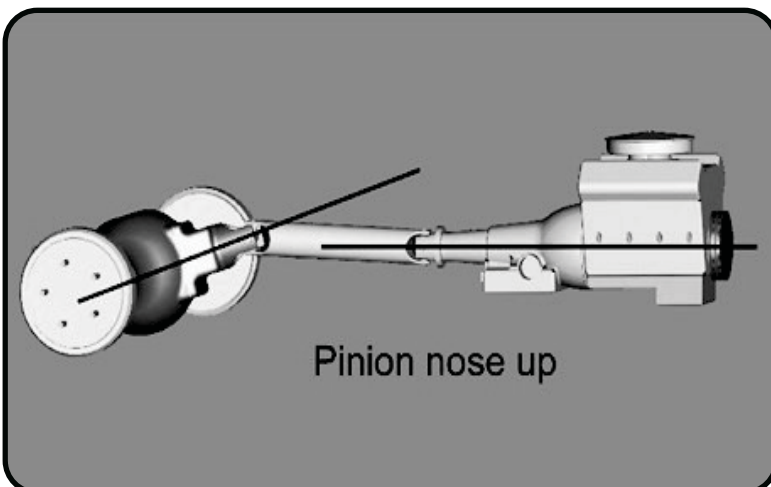
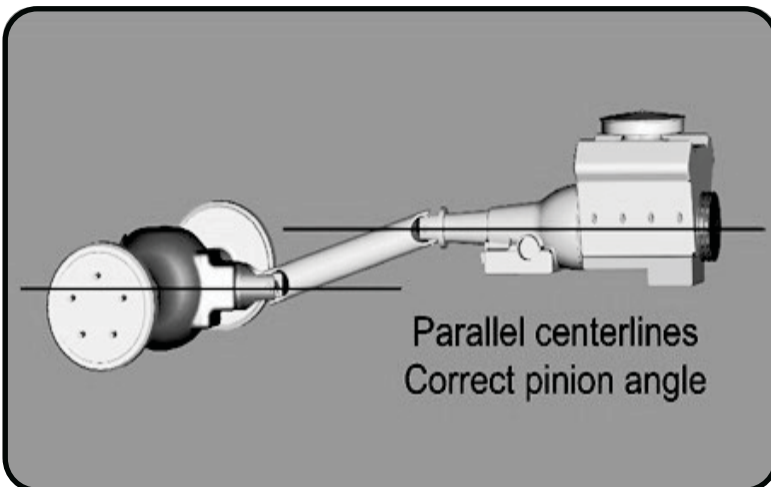
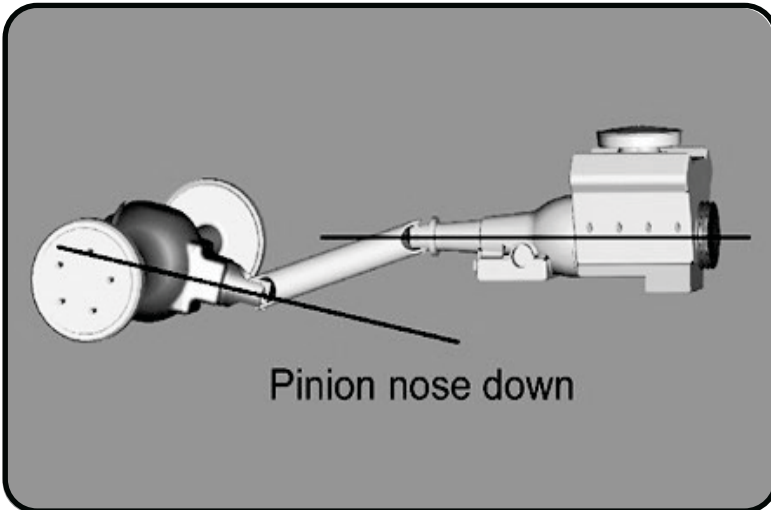



Upper Bar Tab Installation Jig

Upper Bar Installation Jig

- This jig has been supplied to aid in the installation of the upper 4 link bar. It can be temporarily used to properly align, locate and weld the tabs onto the axle. It will also ensure that the mounting bolts are parallel to the ground.
- Follow the diagram below to set the jig to the same length as the upper bar, use the 3/8" x 3/4" bolt and nuts to set the length.
- Position the axle at ride height. Center the axle left to right between the quarter panels. Set pinion angle.
- Bolt one end of the jig to the cradle using a 5/8" x 3" bolt.
- Using another 5/8" x 3" bolt, fasten the axle tabs to the other end. The inner tabs will get bolted to the jig tab with the dog legged edge to the rear. The outer tab will have the long straight edge rearward. The tabs must be bolted to the outside of the jig. Both tabs should have the tab backer locating tabs to the rear of the car.
- Swing the bar down letting the tabs rest onto the axle. Trim the brackets as necessary to minimize the gap to be welded.
- Check pinion angle, ride height and axle center. Tack-weld the tab assemblies in place on the axle.
- Remove jig and install upper bar.
- Repeat this process for the other side.
- Recheck pinion angle, ride height and axle center. (Sound familiar?)
- After the tabs have been tack welded on both sides, remove the setting jig. Let the axle drop down for better access to the tabs. Lay 1" welds on the inside and outside of the tabs. Skip around from one side to the other to avoid overheating the tube.

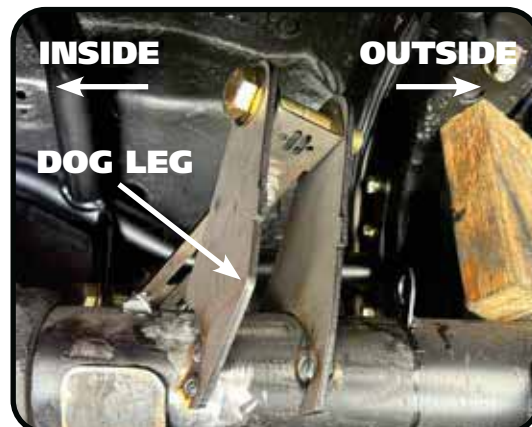
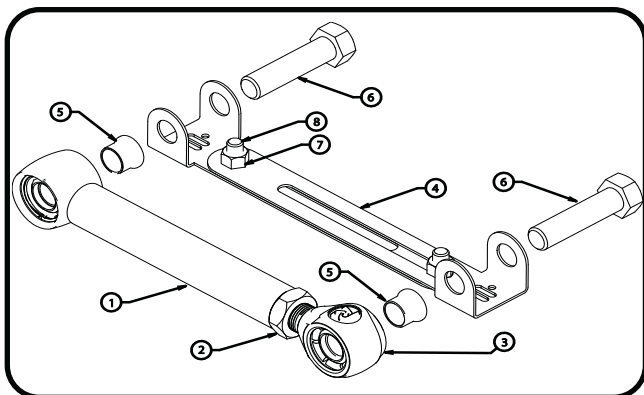

Item#	Description
1	Upper Bar
2	3/4"-16 Jam Nut
3	R-Joint End
4	Alignment Jig
5	Aluminum Spacer
6	5/8" x 2 3/4" Bolt
7	3/8"-16 Nut
8	3/8"-16 x 3/4" Bolt





Installing Upper Bars Tabs



41. One helpful trick to help maintain ride height and pinion angle while adjusting is to tack weld a spacer between the axle and the outside of the frame as shown in the picture. This spacer should be 5 1/2" tall giving the CoilOver/Shockwave an eye-to-eye measurement of approximately 14 1/2". When measuring the axle center you can measure off of the frame rails. We also use a plum bob off the quarter panels to double check the axle center. Refer to **Page 20** on setting the pinion angle.



42. Check the length of the upper bar; it should be 9 1/4" center to center. Bolt the axle tabs to the setting jig as specified on the previous page. Next, place the other end into the cradle. Both ends use a 5/8" x 3" and should not be fully tightened yet. For now just let axle tabs sit on the axle.



43. Check the fitment of the tabs to the axle.



Installing Upper Bars Tabs & Bars



44. Put the tab back brace in position. The curve of the brace should be up. The 2 tabs on each side of the brace need to be positioned on each side of the tab on the REAR of the axle tabs. Tack weld everything in place and repeat for the other set of axle tabs. After the tabs have been tack welded on both sides, remove the setting jig. Let the axle drop down for better access to the tabs. Lay 1" welds on the inside and outside of the tabs. Skip around from one side to the other to avoid overheating the tube.



45. The R-joint uses a .620" spacer (70013334) on each side. Insert the small OD of the spacer into the r-joint center ball. Push the spacers in until they bottom out in the center ball. Do this for both ends of the upper bar.



46. The upper bar mount that is made into the cradle has 2 mounting positions. **THE STANDARD MOUNTING POSITION IS THE BOTTOM HOLE.** Insert the front of the upper bar in the BOTTOM hole of the upper bar mounting. Install a 5/8" flat washer on a 5/8"-18 x 3" hex bolt. Insert the bolt/washer in the aligned holes. Install a 5/8" flat washer and 5/8"-18 nylok nut on the bolt. Repeat on both sides and tighten the bolts/nuts enough to eliminate any gaps.



Installing Upper Bars



47. Verify the spacers are installed in the R-Joints of the upper bars.



48. Insert the R-Joint into the upper bar mount of the rear differential. Install a 5/8" Flat Washer on to a 5/8"-16 x 3" hex bolt. Line up the holes in the axle tabs with the through hole of the R-Joint, insert the bolt/washer.



49. Install a 5/8" flat washer followed by a 5/8"-18 thin jam nylok nut. Repeat on both sides and tighten the bolts/nuts enough to eliminate any gaps.



Installing Lower Shock Stud & CoilOvers/ShockWaves



50. Installing the shock stud into the lower mount. Install a 5/8" flat washer onto the 5/8"-18 threads of the shock stud. Apply Red Loctite to the 5/8" threads of the stud. Thread the shock stud into the threaded hole of the lower mount. Repeat on both sides and torque the shock stud to 65-75 ftlbs.



51. Ridetech CoilOvers or ShockWaves require a spacer on each side of the bearing. The upper crossmember uses a 1/2" ID spacer that is .605" long (90002043). The overall width with a spacer on each side will be 1 1/4". **The small OD of the spacer will insert into the shock bearing.**



52. Insert the 1/2" ID shock bearing spacer into each side of the ShockWave/CoilOver bearing. If installing ShockWaves, insert the top of the shock into the shock mount on the upper crossmember with the adjusting knob to the inside. If installing CoilOver, insert the bottom of the shock into the shock mount on the upper crossmember. Line up the holes in the upper shock mount with the spacers and shock bearing. Install a 1/2"-20 x 2 1/4" Hex Bolt into the lined up holes. Install a 1/2"-20 thin jam nylok nut. Torque to 22 ft-lbs.



Installing CoilOvers/ShockWaves



53. The shock stud requires spacers that are 5/8" ID x .400" long (90002067). Install a 90002067 spacer (**Small side towards shock body**) onto the lower Shock Stud.



54. Slide the bottom of the shock onto the stud. Install a second 5/8" ID 90002067 spacer onto the Stud (**small side towards shock**). You may need to jack the rearend up to slide the shock onto the stud. Install the 7/16" flat washer and 7/16" nylok nut. Tighten the upper and lower shock bolts. Torque the lower nut to 40 ftlbs. The designed ride height of the CoilOver/Shockwave is 14 1/2" center to center.



Anti Squat Adjustment

The Upper Bar Mounts and Lower Axle Mounts are designed with adjustable Anti Squat. Anti Squat reduces the amount the rear suspension squats on acceleration. Anti Squat is measured in a percentage, the higher the percentage of anti squat the less the rear of the car squats. Reducing the rear squat keeps the rear suspension from compressing as much therefor reducing the amount the front suspension extends. This will help keep the suspension geometry in it's optimized range. Anti squat uses the mechanics of the rear suspension to reduce squat rather than the shocks and springs. It uses the same mechanics to help put weight to the rear tires during acceleration. Several factors effect the amount of anti squat a car needs; horsepower, tires, vehicle weight, and track surface are some of the main ones. You can use the different settings in this suspension to help dial in your car's handling. Keep in mind, the higher the rear squat percentage the less effective the rear tires will be under hard braking for corner entry.

We control the Anti squat percentage by raising and lowering the front of the upper bar and rear of the lower bar. The standard position is approximately 55% Anti Squat at the designed ride height. We have found this to be a good starting point and a great setting for driving. Keep in mind, your ride height will affect the anti squat percentage and instant center. ALL OF THESE NUMBERS ARE BASED AROUND 14 1/2" RIDE HEIGHT OF SHOCKWAVE OR COILOVER.

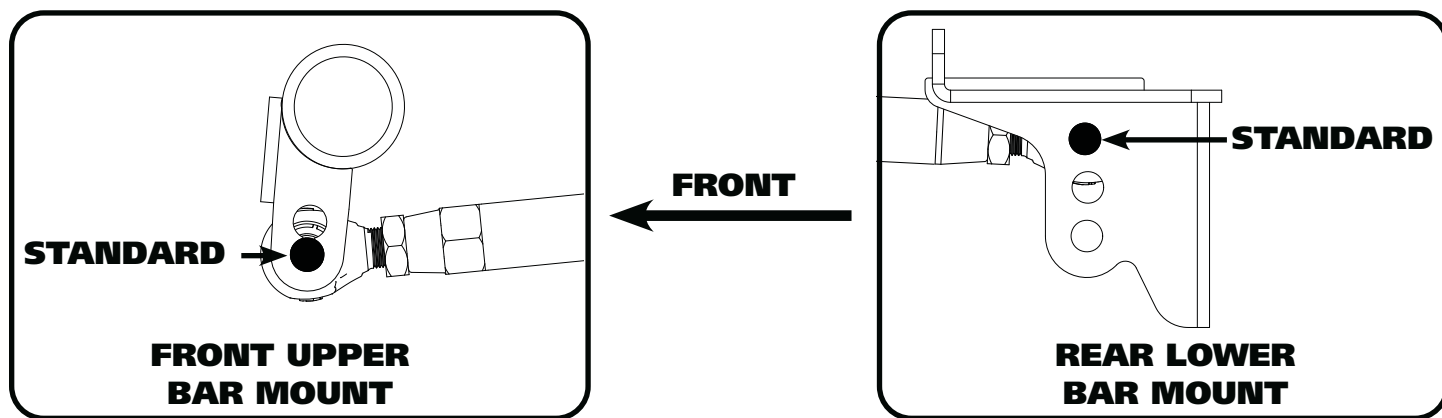

ADJUSTMENT GUIDE

THE STANDARD SETTING IS WITH THE TOP BAR IN THE LOWER HOLE AND THE LOWER BAR IN THE TOP HOLE.

UPPER BAR POSITION	LOWER BAR POSITION	ANTI SQUAT % OF CHANGE FROM STANDARD SETTING	INSTANT CENTER CHANGE
TOP HOLE	TOP HOLE	WE RECOMMEND NOT USING THIS SETTING	
TOP HOLE	MIDDLE HOLE	0 %	+ 80"
TOP HOLE	BOTTOM	+ 30 %	+ 20"
BOTTOM HOLE	MIDDLE HOLE	+ 25 %	- 21"
BOTTOM HOLE	BOTTOM HOLE	+ 50 % *	- 32" *

* This setting is recommended for straight line applications only. The steeper lower bar angle is not recommended for handling applications.