

ridetech



INSTALLATION INSTRUCTIONS



MOMENTUM

CHASSIS SERIES by **ridetech** 

1964-1967 Chevelle/Malibu

KIT #	SPINDLE	REAR AXLE
11233796	Hub	Narrow Width
11233797	Hub	Stock Width
11233798	Pin	Narrow Width
11233799	Pin	Stock Width



www.ridetech.com
812.482.2932



**Please Read And Understand All Instructions
And Warnings Prior To The Installation Of
This Product.**

THANK YOU

Congratulations on your new Ridetech product! It's an honor that you've selected the Ridetech brand to upgrade your ride. Our products are developed around quality and performance without compromise. We're confident you'll have many years (and miles) of pure driving enjoyment.
Thank you for choosing Ridetech!

Road Map

Pre-Installation Notes	3-6
Torque Specifications Summary	7
Components Listing	8
Hardware Kits	9-10
Exploded Views	11-17
Disassembly	18
Lower Control Arms	19
Caster Tutorial	20
Cross Shaft Positioning	21
Upper Control Arms	22-23
Front Coil-overs/Shockwaves	24-25
Steering Rack	26
Engine Mount Bushings	27
Spindle/Hub Assembly	28
Caliper Bracket Assembly	29
Spindle Installation	30
Steering Arms/Tie Rods	31-33
Front Sway Bar	34-36
Upper 4-Link Bars	37-38
Rear Lower Shock Mount	39
Lower 4-Link Bars	40-41
Rear Coil-overs/Shockwaves	42-43
Transmission X-Member & Chassis	44-46
Final Assembly	47-48
R-Joint Bar Assembly	49

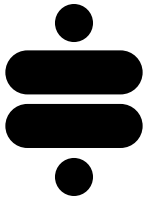

PRE-INSTALLATION NOTES PLEASE READ

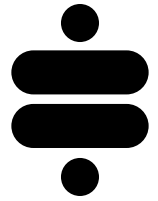

Installing this system requires removal of the engine and transmission. Due to the numerous variations in engine/transmission configurations, customizations, and vehicle conditions, the written instructions on the following pages do not include detailed steps on how to remove your particular engine and transmission.

If you require guidance on the disassembly portion of the install, we recommend referring to the factory service manual, or seeking the assistance of a reputable, experienced mechanic.

STEERING RACK

This system was designed to be used with a '94-'04 Mustang steering rack or a '79-'93 Mustang rack with '94-'04 inner tie rods (metric threads). We used a PSC-RA33501 for the installation outlined in these instructions.

If you are using the stock GM power steering pump, we recommend installing a Borgeson 899001 pressure-reducing kit to lower the pressure of the GM pump. This will improve the feel and response of the Mustang steering rack.

EXHAUST TAIL PIPES

Over-the-axle tail pipes are not compatible with this system.
Tail pipes must be routed under the axle.



PRE-INSTALLATION NOTES PLEASE READ

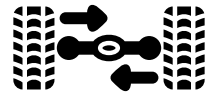

STEERING SHAFT

The steering shaft assembly will need to be configured to fit your vehicle. Ridetech offers some pre-configured kits for the most common applications. It will be necessary to evaluate your specific situation to know what components are right for your build. The headers you are using will have the greatest influence on your steering setup. At Ridetech we have had the best luck with Ultimate Headers, as their designs tend to provide the most clearance.

If your build provides adequate clearance for a straight steering shaft between the upper and lower U-joints, we recommend Ridetech kit # 11009535.

Some engine / header combinations may require an intermediate universal joint in the steering shaft to create additional clearance. Any time more than two universal joints are used, a shaft support is necessary to prevent the shaft from “looping”. We have included mounting provisions on the chassis that accept an adjustable shaft-support assembly.

If your build requires the additional U-joint for steering shaft clearance, Ridetech kit # 11249511 includes all the necessary hardware and components for this type of configuration, and was developed specifically for use with the Ridetech Momentum chassis.

When determining the position for the shaft support, it will be necessary to mock up the entire steering shaft assembly to balance out all of the variables and find a configuration that works. Pay close attention to the manufacturer’s recommendations for maximum working angles and phasing of the joints. Base your layout around those guidelines. Too much angle in any one of the joints may cause binding and poor steering.

Wooden dowels work well to mock up sections of shaft before cutting. We also recommend locking down all of the connections on the steering shaft with the car sitting on the ground, and on its own weight. This will remove any flex in the car’s body that might create a binding situation.

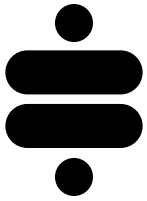

PRE-INSTALLATION NOTES PLEASE READ

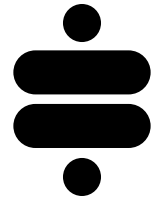

FUEL TANKS

This system is compatible with stock or stock-style fuel tanks.

You may find it necessary to bend or trim the front corners of the weld seam to gain adequate clearance as shown below.



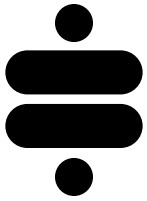

PRE-INSTALLATION NOTES PLEASE READ

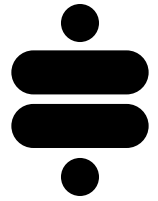

ENGINE MOUNTS

This system requires the use of one of the engine mount options listed below (purchased separately).

ENGINE MOUNT OPTIONS	
DESCRIPTION	RIDETECH KIT #
Chevy Small / Big Block	11169511
GM LS	11169512
GM Gen V LT	11169514
Oldsmobile Small / Big Block	11169517
Buick Big Block	11169518

Ridetech recommends this system be installed by a professional technician or experienced, reputable mechanic. Modification or improper installation of this product may result in loss of warranty. Proper installation and setup of your suspension is critical to the safe and enjoyable operation of your vehicle. Failure to follow the guidelines and specifications provided in these instructions may result in damage to your vehicle and/or death or serious injury to you, your passengers, or other motorists. Ridetech will not be held liable for any damage, loss or injury occurring from the use of this product outside of its intended application and design parameters.



TORQUE SPECIFICATIONS



LOCATION	TORQUE SPEC
1/2"-13 Lower Control Arm Bolts	75 ft-lbs
7/16"-20 Upper Control Arm Bolts	50 ft-lbs
5/8" Cross Shaft Lock Nuts	55 ft-lbs
1/2"-13 Upper & Lower Shock Bolts	75 ft-lbs
1/2"-13 Steering Rack Bolts	75 ft-lbs
3/8"-16 Steering Shaft Bearing Mount	32 ft-lbs
M12 Hub To Spindle Bolts	99 ft-lbs
1/2"-13 Caliper Bracket To Spindle Bolts	90 ft-lbs
1/2"-13 Steering Arm Bolts	90 ft-lbs
1/2"-20 Steering Arm Bolts	100 ft-lbs
Upper Ball Joint Nut	50 ft-lbs
Lower Ball Joint Nut	65 ft-lbs
1/2"-20 Tie-Rod Stud Castle Nut	35 ft-lbs
3/8"-16 Sway Bar Mounting Strap Bolts	32 ft-lbs
1/4"-28 Sway Bar Collar Bolts	13 ft-lbs
M12 Sway Bar End Link Nuts	85 ft-lbs
1/2"-13 Rear Lower Shock Mount Bolts	75 ft-lbs
Lower Shock Mount Stud	65-75 ft-lbs
1/2"-13 Rear Upper Shock Bolts (thin nylok nut)	55 ft-lbs
7/16"-20 Rear Lower Shock Bolts	40 ft-lbs
7/16"-14 Radiator Support Bolts (Location "A")	45 ft-lbs
7/16"-14 Chassis Bolts (Location "B")	70 ft-lbs
3/8"-16 Transmission X-Member Bolts	32 ft-lbs
M14 Caliper To Caliper Bracket Bolts	125 ft-lbs

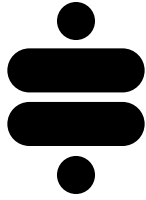

COMPONENTS LISTING



ITEM #	PART #	DESCRIPTION	QTY
1	90003942	64-67 A-Body Chassis	1
Transmission Crossmember: 11243752			
2	90003944	Transmission Crossmember	1
2a	90003890	Spacer Block	1
UPPER CONTROL ARMS: 11243690			
3	90003891	Upper Control Arm - Driver (SHOWN)	1
4	90003892	Upper Control Arm - Passenger	1
5	70010759	Delrin Bushing, 2.0" Large OD	4
6	70010826	Delrin Bushing, 1.5" Large OD	2
7	70010827	Delrin Bushing, 1.750" Large OD	2
8	70010883	Caster Slug	4
9	90000908	Ball Joint: Proforged 101-10015	2
10	90002737	Aluminum Washer	4
11	90003375	Caster Adjustable Cross Shaft	2
12	99622005	5/8-18 Thin Locknut	4
13	90003933	WASHER; 1.45 OD	2
14	90003934	WASHER; 1.70 OD	2
15	99251022	1/4-20 X 1" Hex Cap Screw, Black	8
16	99252006	1/4-20 Nyloc Nut	8
17	99253012	1/4 SAE Flat Washer	8
LOWER CONTROL ARMS: 11242890			
18	90003893	Lower Control Arm - Driver (SHOWN)	1
19	90003894	Lower Control Arm - Passenger	1
20	70010759	Delrin Bushing	8
21	90000516	Inner Sleeve (Short)	2
22	90003914	Inner Sleeve (Long)	2
23	90000898	Ball Joint: Proforged 101-10013	2
FRONT SWAY BAR: 11239105			
24	90003939	Front Sway Bar	1
25	90001346	Sway Bar Mount	2
26	70015016	Sway Bar Bushing	2
27	90003843	90-Degree End Link - 12mm	4
28	90003899	End Link Spacer	2
29	99125005	M12 X 1.75 X 80mm Fully Threaded Stud	2
30	99123003	12mm Copper Crush Washer	2
31	90003650	Captured Nut	4
32	70014491	1.5" Sway Bar Clamp Collar	2

ITEM #	PART #	DESCRIPTION	QTY
STEERING KIT: 11249510			
33	90003897	Steering Arm - Driver	1
34	90003898	Steering Arm - Passenger	1
35	70017522	Tie Rod End	2
37	70015348	Poly Bushing (Pack of 4)	1
38	90001624	Rear Lower Shock Mount	2
39	70002825	Rear Lower Shock Mount Stud	2
40	90002067	Rear Lower Shock Spacer	4
-	90002672	Bushing Sleeve	2
4-LINK BARS: 11237298			
41	90003169	Upper 4-Link Bar	2
42	90003941	Lower 4-Link Bar	2
43	90001318	R-Joint - RH	4
44	90001319	R-Joint - LH	4
45	70013334	R-Joint Spacer	16
BODY BUSHINGS: 11243751			
46	70017476	Body Bushing - Upper	16
47	70017475	Body Bushing - Lower	12
48	90003906	Sleeve	14
49	90003904	Body Mount Lower Washer	12
50	90003905	Body Mount Shim	34
REAR HOUSING AND AXLES - STANDARD WIDTH (Only with 11233799 or 11233797 Kits)			
51	11239684	Ridetech Ford 9" Housing and Axles	1
REAR HOUSING AND AXLES - NARROW WIDTH (Only with 11233798 or 11233796 Kits)			
52	11239685	Ridetech Ford 9" Housing and Axles	1
PIN SPINDLES: 11009303 (Only with 11233799 or 11233798 Kits)			
53	11009304	RideTech 2" Drop Spindle	2
54	99501054	1/2-20 x 2 1/2" FHCS GR8	4
HUB SPINDLES: 11009312 (Only with 11233797 or 11233796 Kits)			
55	70015750	Ridetech Hub Spindle	2
56	90003535	Threaded Insert	4
CALIPER BRACKETS: 11009546 (Only with 11233797 or 11233796 Kits)			
57	90003547	Caliper Bracket - Passenger	1
58	90003548	Caliper Bracket - Driver	1
59	90003549	Caliper Bracket Spacer	4

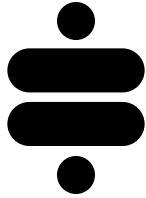

HARDWARE KITS



FRONT SWAY BAR HARDWARE KIT - 99010281			
ITEM #	PART #	DESCRIPTION	QTY
FRONT SWAY BAR			
60	99122009	M12 -1.75 NYLOK NUT	4
61	99123002	M12 FLAT WASHER	8
62	99371005	3/8-16 X 1.25 HEX BOLT	4
63	99372001	3/8-16 NYLOK NUT	4
64	99373002	3/8 FLAT WASHER	8

4-LINK BARS HARDWARE KIT - 99010284			
ITEM #	PART #	DESCRIPTION	QTY
4-LINK BARS			
84	99621004	5/8-18 X 3 HEX BOLT	8
12	99622005	5/8-18 THIN NYLOK NUT	8
85	99623010	5/8 SAE WASHER	16
4-LINK BAR ASSEMBLY			
86	99752004	3/4-16 HEX FIN JAM NUT	4
87	99752006	3/4-16 LH HEX FIN JAM NUT	4
-	90002276	ANTI-SEIZE COMPOUND	2

BODY BUSHINGS HARDWARE KIT - 99010285			
ITEM #	PART #	DESCRIPTION	QTY
BODY BUSHINGS			
88	99431025	7/16-14 X 3" HEX BOLT	2
89	99431033	7/16-14 X 2.25" HEX BOLT	12
90	99432010	7/16-14 NYLOK NUT	2
-	99431037	7/16-14 X 2.50" HEX BOLT GR8 (Optional)	12

CHASSIS HARDWARE KIT - 99010283			
ITEM #	PART #	DESCRIPTION	QTY
STEERING ARMS			
65	99501043	1/2-13 x 2 HEX BOLT	4
66	99503014	1/2" SAE WASHER	4
67	90002263	RED LOCTITE	1
REAR SHOCKS/MOUNTS			
68	99501026	1/2-13 X 2.25 HEX BOLT	2
69	99502007	1/2-13 THIN NYLOK	2
70	99501019	1/2-13 X 1.25 HEX BOLT	2
71	99501046	1/2-13 X 1.75 HEX BOLT	2
72	99502001	1/2-13 NYLOK NUT	4
73	99432002	7/16-20 NYLOK NUT	2
74	99433002	7/16 SAE WASHER	2
75	99623004	5/8 SAE WASHER	2
FRONT SHOCKS			
68	99501026	1/2-13 X 2.25 HEX BOLT	2
69	99502007	1/2-13 THIN NYLOK NUT	4
76	99501003	1/2-13 X 2.5 HEX BOLT	2
UPPER CONTROL ARMS			
77	99431020	7/16-20 X 2.5" HEX BOLT	4
78	99432007	7/16-20 NYLOK NUT	4
79	99433005	7/16 SAE WASHER	8
LOWER CONTROL ARMS			
80	99501065	1/2-13 X 3.75 HEX BOLT	2
81	99501063	1/2-13 X 4.25 HEX BOLT	2
66	99503014	1/2 SAE WASHER	8
82	99502009	1/2-13 NYLOK NUT	4
STEERING RACK			
83	99501081	1/2-13 X 9 HCS GR8	2
82	99502009	1/2-13 USS Gr. 8 NYLOK NUT	2
66	99503014	1/2 SAE FLAT WASHER GR8	2
-	99503021	1/2" USS FLAT WASHER GR8 YZ	2
TRANSMISSION CROSSMEMBER			
62	99371005	3/8-16 X 1 1/4 HCS GR8	4
63	99372001	3/8-16 GR 8 NYLOK NUT	4
64	99373002	3/8 SAE FLAT WASHER GR 8	8

HARDWARE KITS

C5/C6 CALIPER BRACKETS HARDWARE KIT - 99010239			
ITEM #	PART #	DESCRIPTION	QTY
BRACKET TO CALIPER			
92	99141007	M14-2.0 x 45MM HEX HEAD	4
93	99143001	M14 FLAT WASHER, GRADE 10.9	4
BRACKET TO SPINDLE			
94	99501062	1/2-13 X 1 1/4" HEX CAP SCREW GR 8	2
66	99503014	1/2 SAE FLAT WASHER GR8	2
95	99501075	1/2-13 X 1 1/4" FHSCS GR8	4
96	99503017	1/2" MIL SPEC WASHER, (OPTIONAL SHIM)	6
SHIM PACK (Not Shown)			
-	99623005	5/8 MIL SPEC WASHER (THICKNESS 0.013-0.019)	8
-	99623006	5/8 MIL SPEC WASHER (THICKNESS 0.028 - 0.036)	8

HUB SPINDLE HARDWARE KIT - 99010230			
ITEM #	PART #	DESCRIPTION	QTY
SPINDLE TO HUB			
91	99121020	M12-1.75 X 40 SHCS, BLACK	6
-	90002263	Red Loctite Tube; 1ml Tube	1
STEERING ARMS (Hardware Below Not Used In This Kit)			
-	99501043	1/2-13 X 2 Hex Cap Screw GR8	2
-	99501026	1/2-13 X 2 1/4 Hex Bolt GR8	2
-	99503014	1/2 SAE FLAT WASHER GR8	4

PIN SPINDLE HARDWARE KIT - 99010174			
ITEM #	PART #	DESCRIPTION	QTY
STEERING ARM TO SPINDLE			
54	99501054	1/2-20 x 2 1/2 FSCS	2
97	99502002	1/2-20 SAE GR8 NYLOK NUT	6
NOT REQUIRED FOR THIS KIT			
NA	99501071	1/2-20 x 3 FSCS	4
NA	99621001	5/8-18 x 1 BOLT GR8	2
NA	99502005	1/2-20 X 2 BOLT GR8	2
NA	99952003	1/8 x 1-1/2 COTTER PINS	4

EXPLODED VIEWS UPPER & LOWER CONTROL ARMS

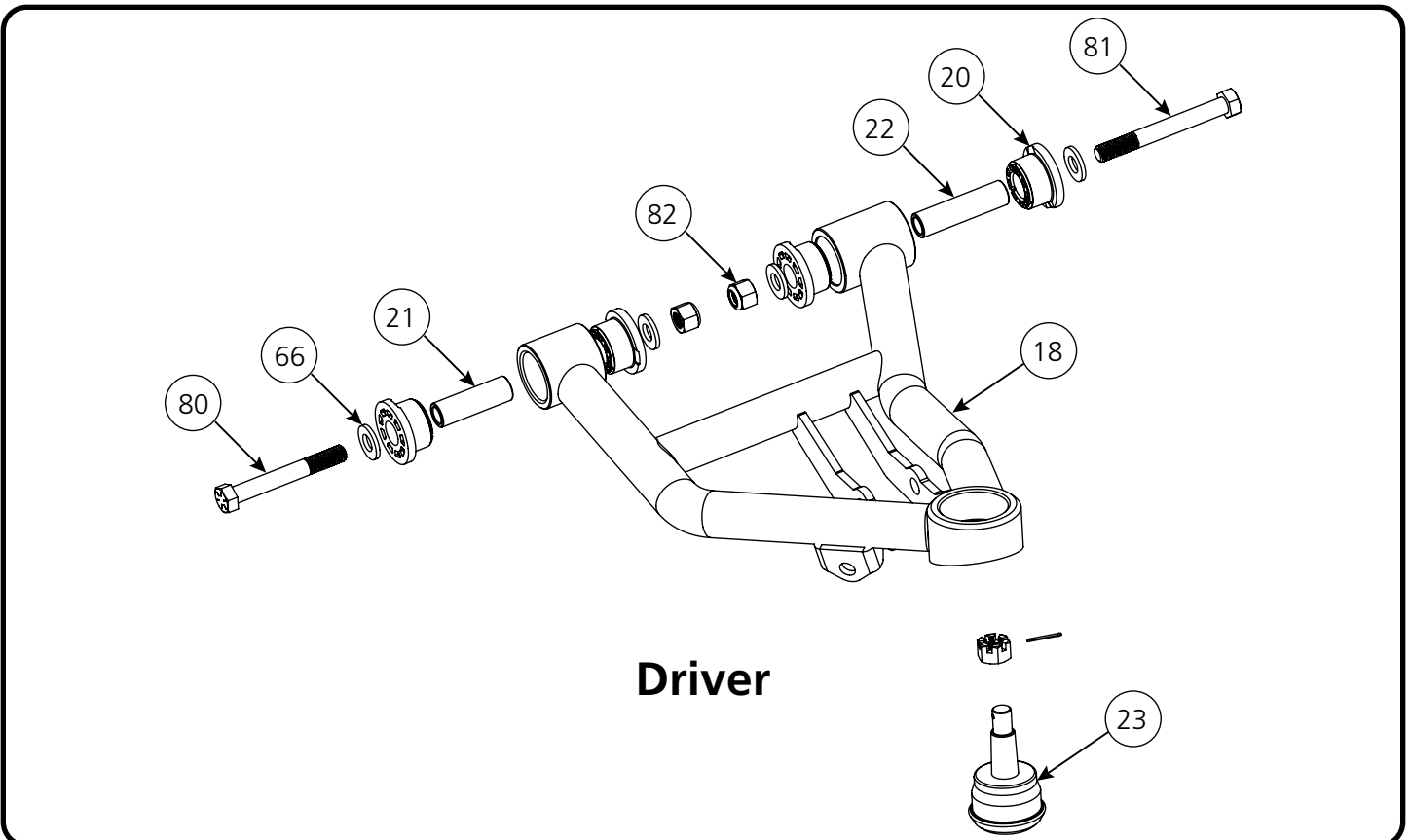
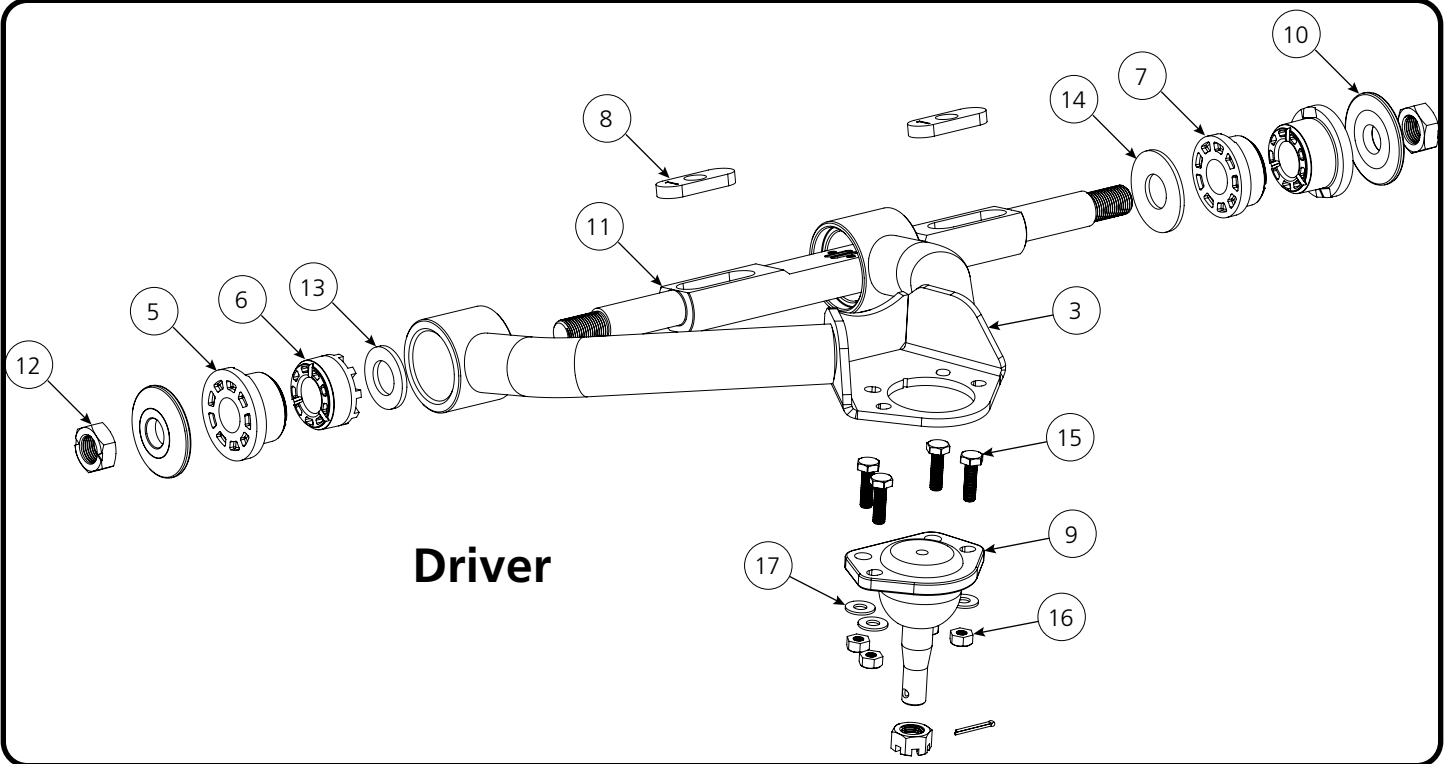

EXPLODED VIEWS FRONT SWAY BAR

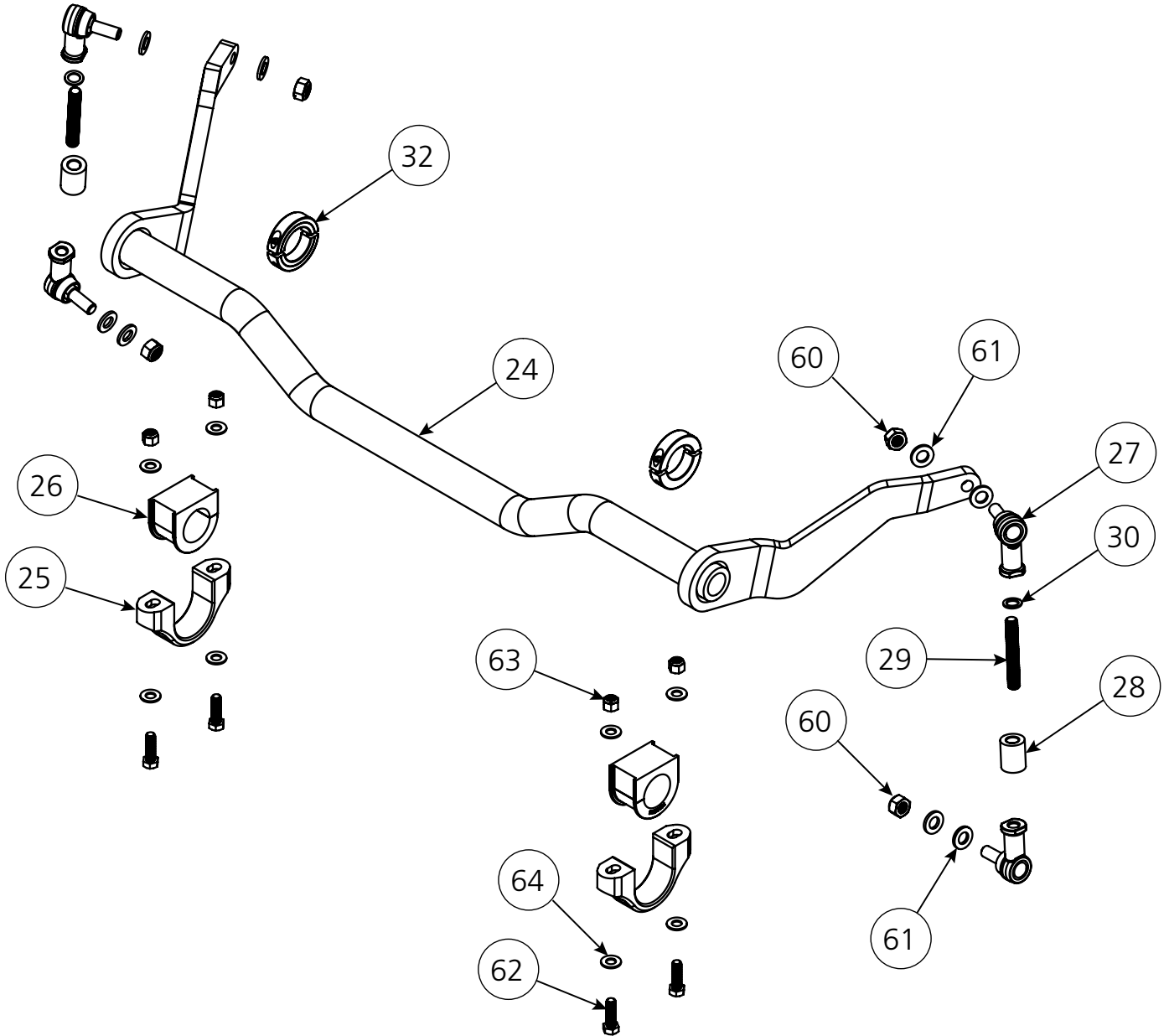

NOTE:
The sway bar bushings in this kit contain an anti-friction lining.
No lubrication is required.

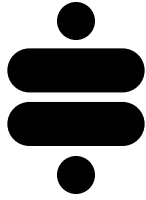

EXPLODED VIEWS HUB SPINDLE STEERING

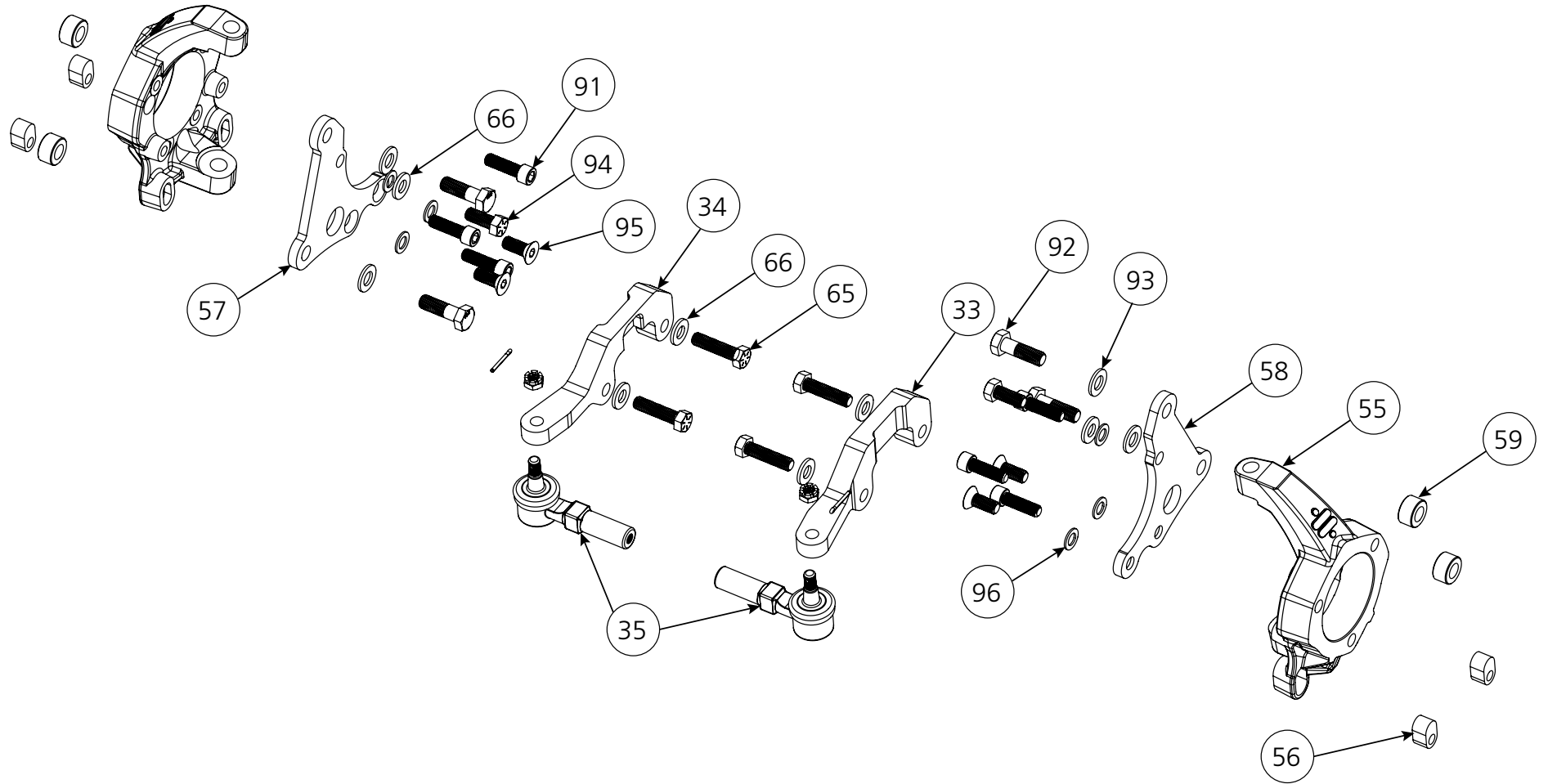

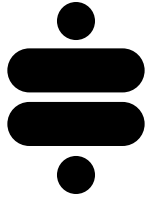

EXPLODED VIEWS "PIN" SPINDLE STEERING

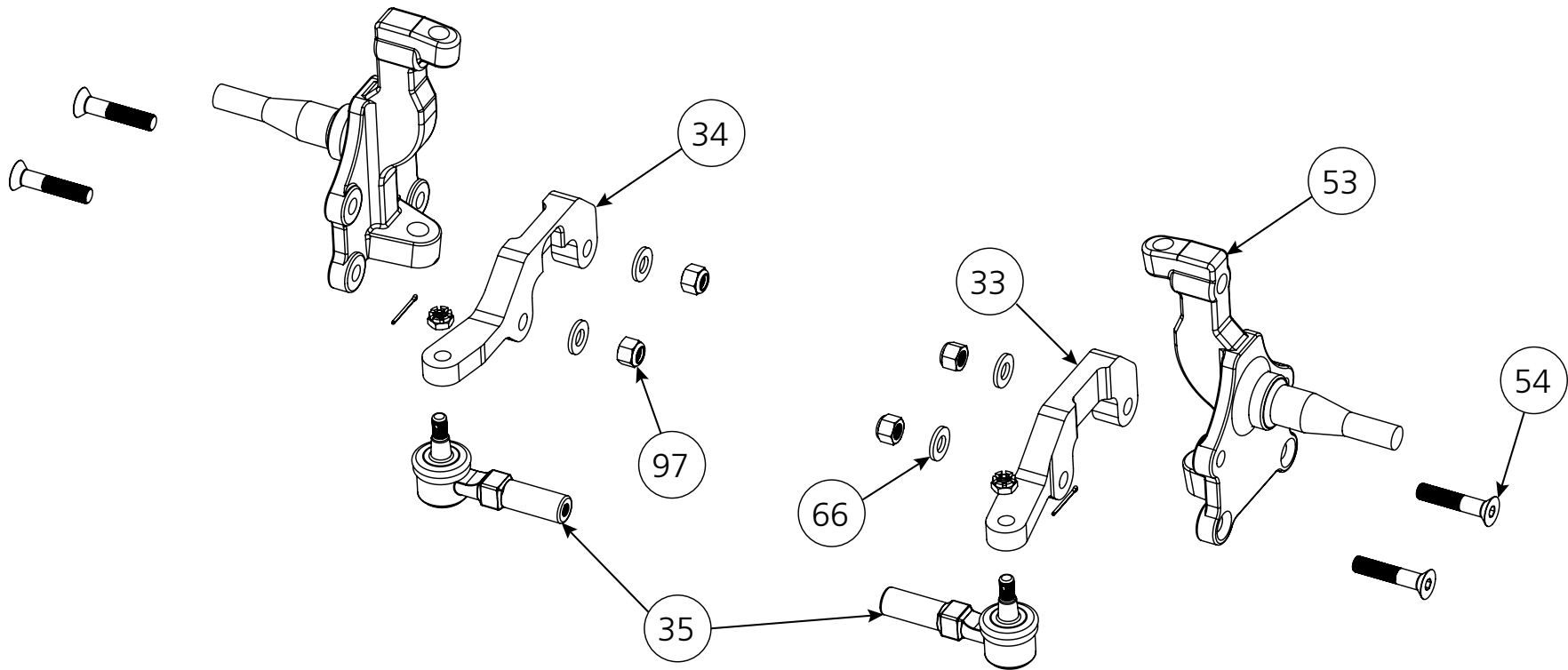

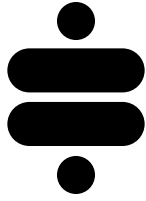

EXPLODED VIEWS

Rear Lower Shock Mounts

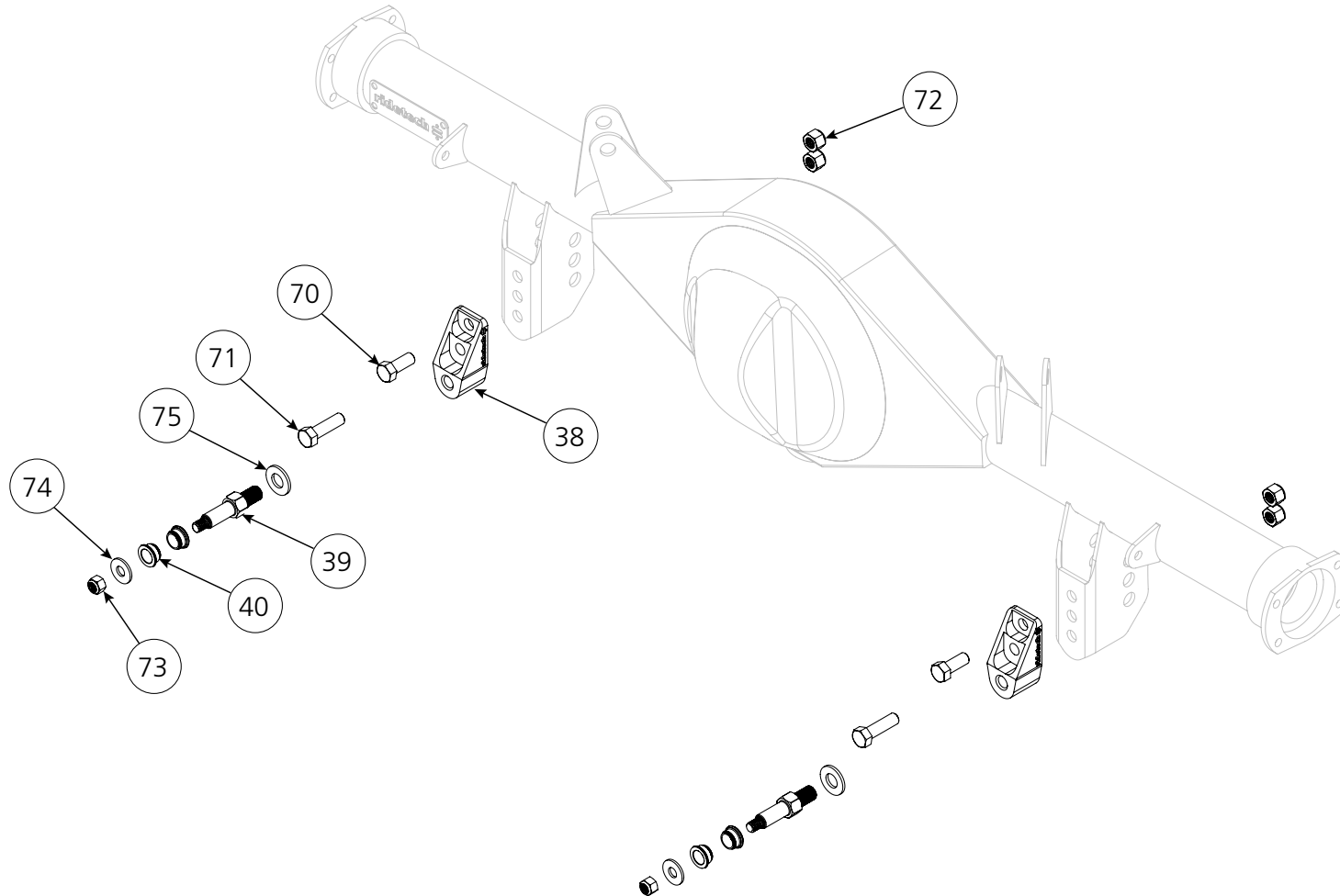

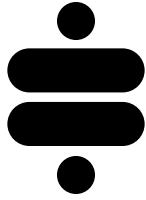

EXPLODED VIEWS

CHASSIS, BODY BUSHINGS, X-MEMBER

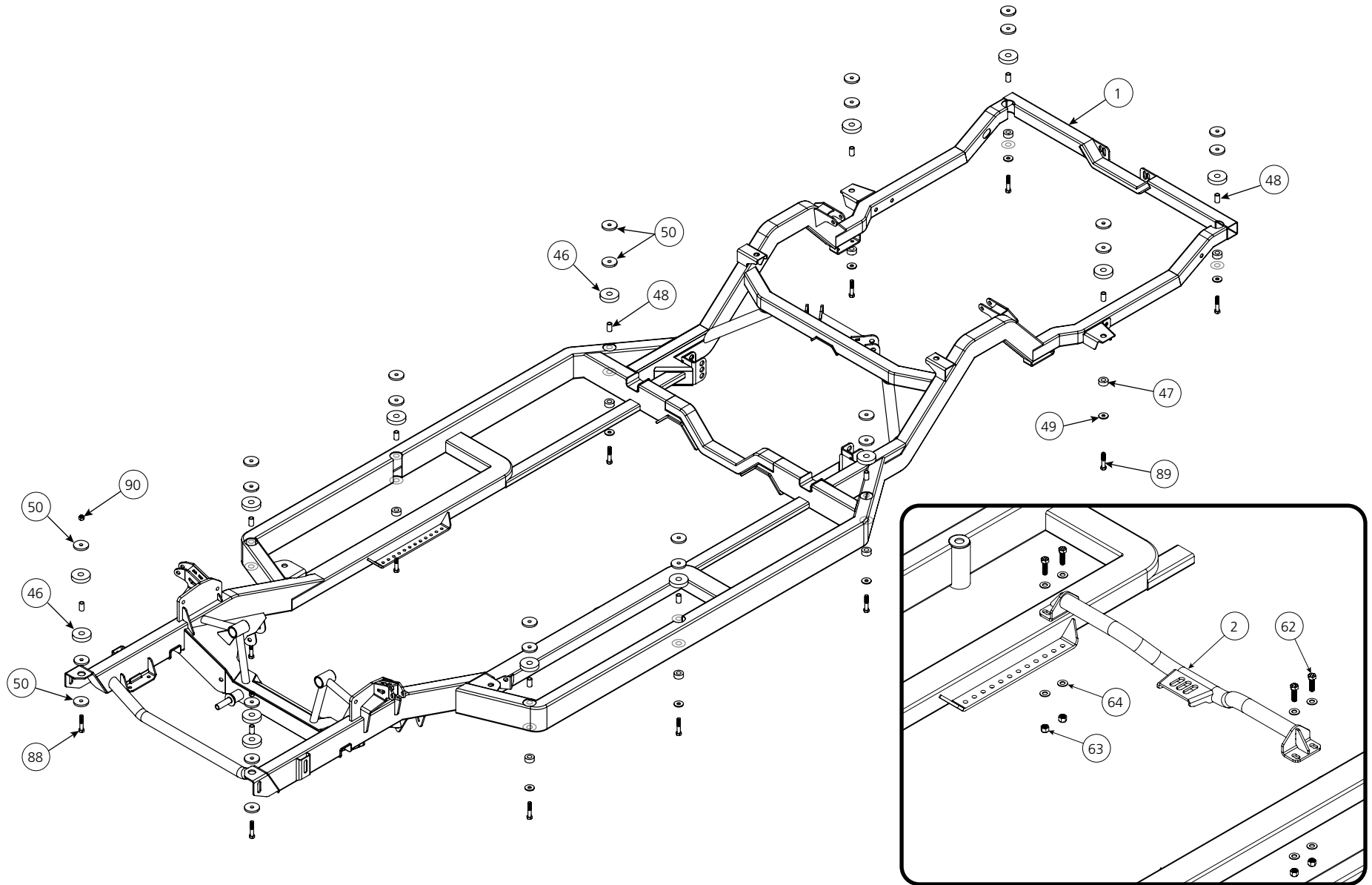
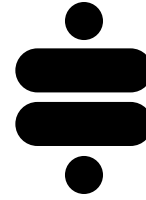

Disassembly

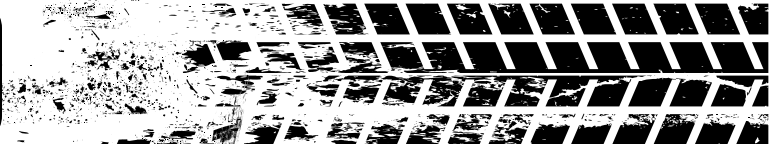

NOTE: If you would like your engine and transmission to be reinstalled in the same position on the new chassis, we recommend documenting the measurements listed below prior to beginning any disassembly.

Engine Position

Side-To-Side

Front-To-Back

*Measure from reference points on the car that will not change during the installation process.

Transmission Angle

A digital angle finder gauge works well for this.

1. Remove the existing chassis/engine/transmission from the car. It may be beneficial to take a handful of photos before disconnecting harnesses, hoses, etc. These photos may be useful during reassembly.

NOTE: If you have access to a lift, you may not need to remove the engine and transmission separately from the existing frame. We lifted the body and removed the engine/transmission and existing chassis as an assembly.

If you do not have access to a lift, you may find it easier to remove the engine and transmission prior to separating the body and chassis.

Once the body and old chassis have been separated, you may begin assembling the new chassis.



Lower Control Arms

2. Position the lower control arm in the mounting flanges on the new chassis (Figure 1).

NOTE: The ball joint should be offset to the rear of the vehicle as illustrated in Figure 2.

3. Install a 1/2"-13 x 4.25" bolt with washer through the rear mounting flange/bushing, and a 1/2"-13 x 3.75" bolt with washer through the front mounting flange/bushing (Figure 3).

4. Install a 1/2" washer and Nylok nut on each mounting bolt and torque to **75 ft-lbs** (Figure 3).

Repeat steps 2-4 on the opposite side.



Figure 1

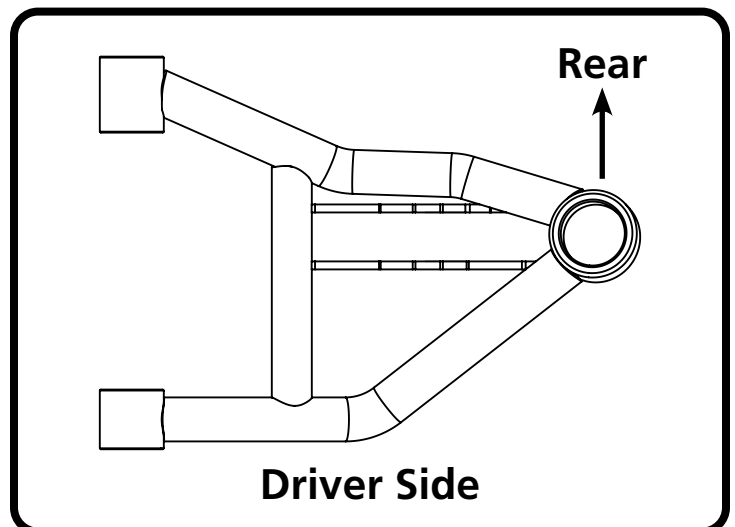
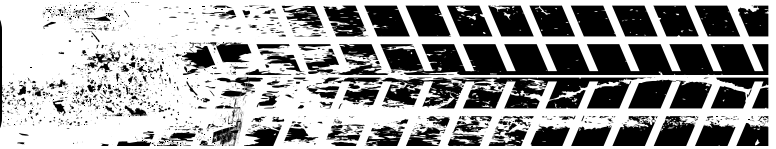

Figure 2



Figure 3

Caster Tutorial



Caster Defined:

To understand caster, you need to picture an imaginary line that runs through the upper ball joint and extends through the lower ball joint. From the side view, the imaginary line will tilt forward or backward. The tilting of this imaginary line is defined as caster.

Caster is measured in degrees by using a caster gauge. If the imaginary line described above tilts towards the back of the vehicle at the top, then you have positive caster. If the imaginary line tilts forward then you have negative caster.

Positive caster provides directional stability in your vehicle. Too much positive caster will make the steering effort difficult. Power steering will allow you to run more positive caster. Negative caster requires less steering effort but will cause the vehicle to wander down the highway.

These StrongArms come equipped with a changeable caster slug setup. This allows you to add or remove caster from the front suspension. The caster slugs supplied in the kit are set up to be centered. The caster slugs allow you to add or remove caster without having to use a stack of shims. If more or less caster is desired, optional slugs listed below can be purchased from Ridetech or your Ridetech dealer.

- Centered:** 70010883 (supplied with control arms)
- 1/8":** 70010882
- 1/4":** 70010881

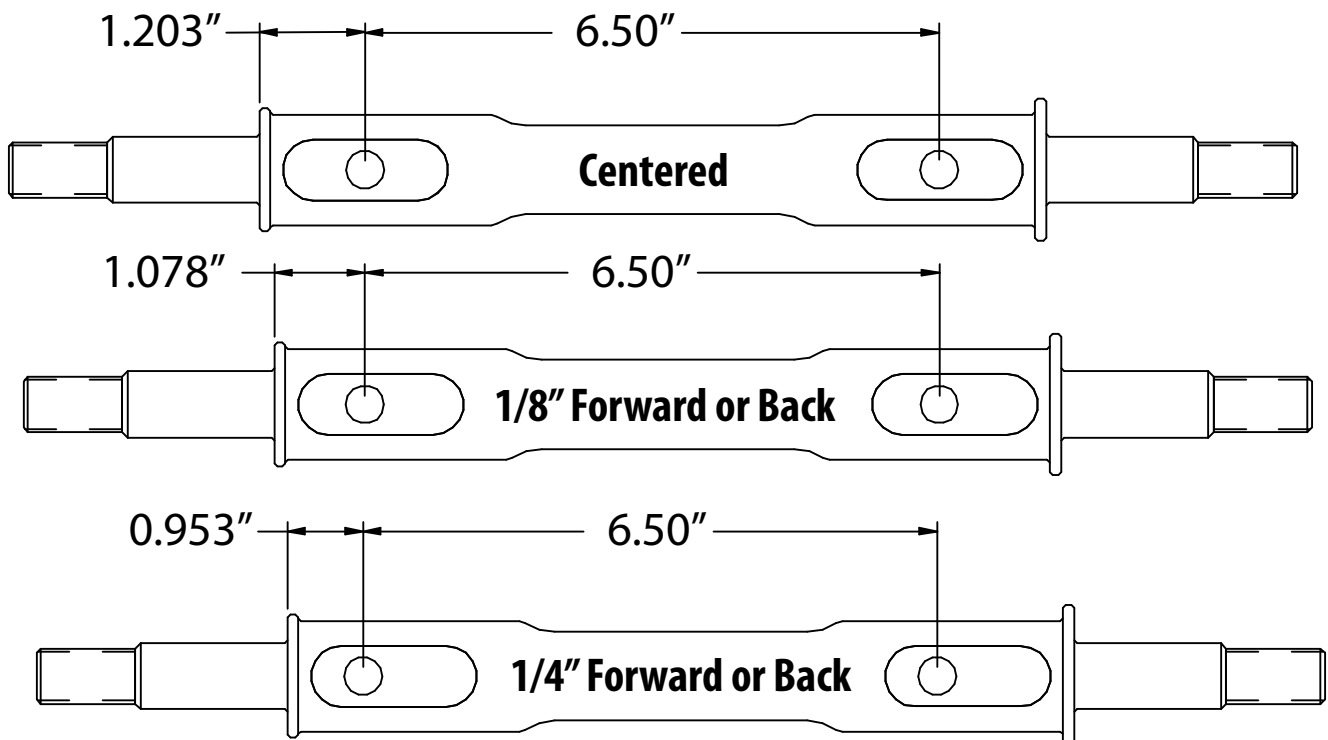

Cross Shaft Positioning

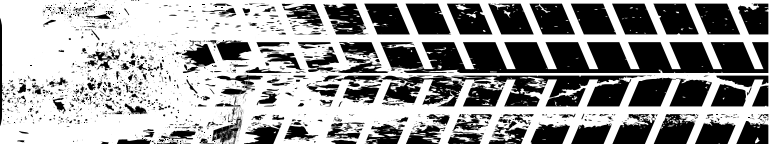

The cross shaft that is used in the upper control arms is offset. The offset combined with the caster slug option allows you to achieve the alignment setting you desire with minimal shims. To change the direction the Icon faces, simply spin the cross shaft in the control arm.

If you are after a **Street Alignment**, bolt the upper control arm to the frame mount with the arm offset to the outside of the car. The Ridetech Icon and Caster Slugs will be facing the wheel.

If a more aggressive **Track or Autocross** alignment is desired, bolt the control arm to the frame bracket with the arm offset to the inside of the car. The Ridetech Icon and Caster Slugs will be facing the engine.

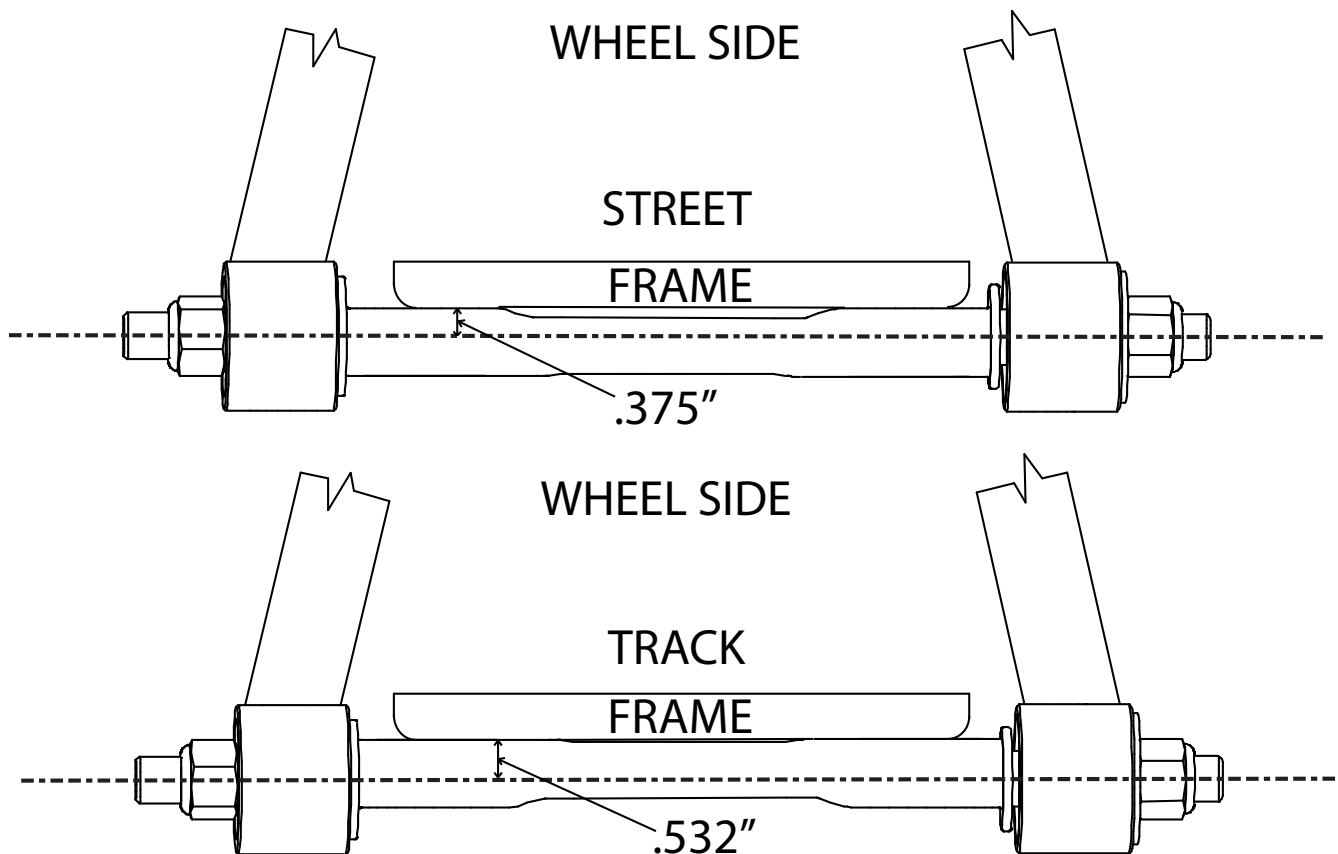

Upper Control Arms

5. Install a 90002737 Aluminum Washer and 5/8" -18 Thin Locknut on each of the threaded ends of the upper control arm cross shaft (Figure 4). You may leave the nuts hand tight for now. They will be tightened after the arm is installed on the chassis.

6. Rotate the cross shaft to the alignment position that best accommodates your driving style as outlined in "Cross Shaft Positioning" on the previous page.

7. Install a 70010883 Caster Slug into each of the recessed openings on the cross shaft (Figure 5).

For additional caster settings and slug options, see the "Caster Tutorial" on page 20.

NOTE: If you are using the optional offset caster slugs (purchased separately), they will be stamped with either "2" or "3". When installing in the cross shaft, make sure the stamped numbers are oriented in the same direction. Orientation does not matter with the slugs stamped with a "1" since the holes are centered.

8. Before installing the arm, ensure you have the correct arm on the correct side. The Ridetech sticker on the arm should be to the front of the vehicle. See Figure 6.



Figure 4

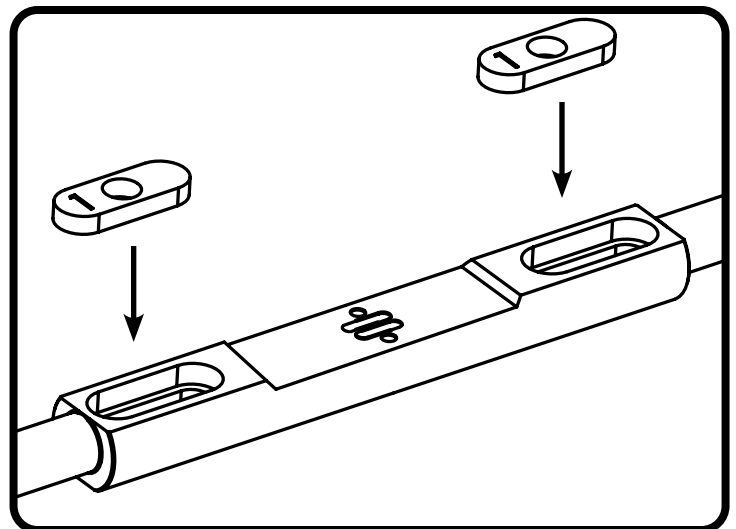

Figure 5



Figure 6

Upper Control Arms

9. Position the arm on the upper control arm mounting flange and insert a 7/16" -20 x 2.5" bolt with washer through each of the mounting holes and caster slugs (Figure 7).

10. Install a 7/16" washer and Nylok nut on each mounting bolt and torque to **50 ft-lbs** (Figure 8).

11. Torque the 5/8" locknut on each end of the control arm cross shaft to **55 ft-lbs**.

Repeat steps 5-11 on the opposite side.

NOTE: This is a good time to install your front Ridetech Coil-overs or Shockwaves (purchased separate). The mounting hardware is included in this kit (99010283).



Figure 7



Figure 8



Figure 9

Front Coil-overs/Shockwaves

12. Insert a 90002040 spacer into each side of the bearing on the shock body. The small end of the spacer will snap into the bearing (Figure 10).



Figure 10

13. Position the coil-over between the straps in the lower control arm and align the holes (Figure 11).



Figure 11

14. Insert a 1/2" x 2.5" bolt through the bearing/mount and secure with a 1/2" washer and nylok nut (Figure 12).

Torque to **75 ft-lbs.**



Figure 12

Front Coil-overs/Shockwaves

15. Insert a 90002043 spacer into each side of the eyelet bearing. The small end of the spacer will snap into the bearing (Figure 13).

16. Position the coil-over eyelet in the upper shock mount and align the holes. Ensure the adjustment knob is facing outboard (Figure 14).

17. Insert a 1/2" x 2.25" bolt through the bearing/mount and secure with a 1/2" washer and nylok nut (Figure 15).

Torque to **75 ft-lbs.**



Figure 13



Figure 14



Figure 15

Steering Rack

18. Press a 70015348 poly bushing into each side of your steering rack mounting flanges (Figure 16).

19. Slide the steering rack onto the mounting posts on the new chassis (Figure 17).

The steering rack shown in the install photos is a PSC RA-33501 (You may have to call PSC to order. It is not currently listed on their website).

NOTE: Rack limiters may be necessary depending on your wheel & tire combination.

20. Install a 1/2"-13 x 9" bolt with 1/2" USS flat washer through each steering rack mounting post (Figure 18). A few light taps with a hammer might be required to fully seat the bolts.

21. Install a 1/2" SAE flat washer and nylok nut on each bolt and torque to **75 ft-lbs** (Figure 19).



Figure 16



Figure 17



Figure 19



Figure 18

Engine Mount Bushings

22. Insert a 90002672 bushing sleeve into one of the 70015348 poly bushings. Slide the combo into one of the engine mount arm sleeves, then install another poly bushing into the opposite side of the arm sleeve (Figure 20).

The smaller OD end of the poly bushing slides into the arm sleeve.

23. Tap the bushing sleeve into the poly bushings until it is flush with the face of the poly bushing. You may have to hold the poly bushing on the opposite end so it does not push out (Figure 21).

24. Use some type of clamping tool to ensure the poly bushings and sleeves are fully seated in the engine mount arm sleeve (Figure 22).

A C-Clamp Vice Grip works well for this.

25. Repeat on the other engine mount arm.



Figure 20



Figure 21

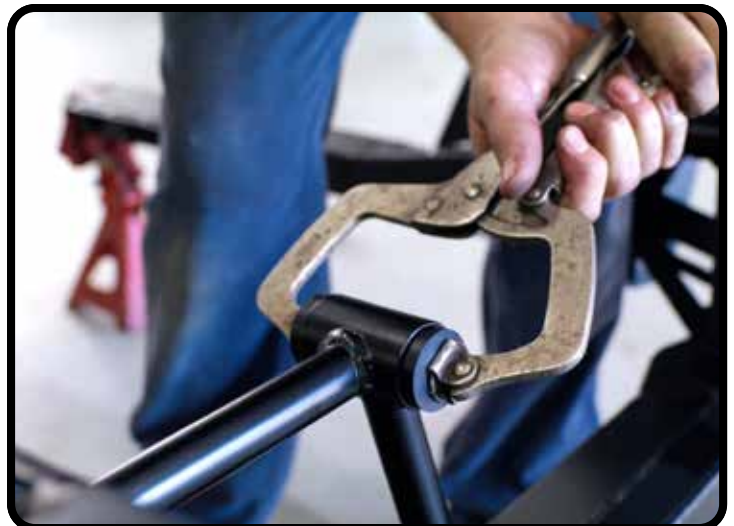

Figure 22

Spindle/Hub Assembly (11243796/97 Only)

*** If you are installing the 11243798/99 "Pin" Spindle kit, you may skip steps 22-27 and jump to step 28. For the 11243796/97 Hub Spindle kit, continue to step 22 below.**

22. Position the Ridetech spindle onto the hub/bearing assembly and align the mounting holes in the hub/bearing assembly with the three counter-bored holes in the spindle (Figure 20).

NOTE: The hub assemblies are purchased separately. The ridetech spindle is designed to be used with C5/C6/C7 Corvette hubs. If you do not require a speed sensor, we recommend using C7 hubs. They are stronger and more cost effective. We used Moog 513378 hub assemblies.

23. Apply Loctite to (3) M12-1.75 x 40mm socket-head bolts from the 99010230 hardware kit (Figure 21).

24. Install the three socket-head bolts to attach the spindle to the hub (Figure 22).

Tighten the bolts and torque to **99 ft-lbs.**

Repeat for the other hub & spindle.



Figure 20

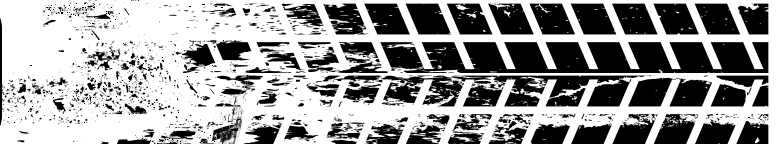

Figure 21



Figure 22

Caliper Brackets (11243796/97 Only)



NOTE: We recommend mocking up the brake assembly with clean, dry threads before applying loctite to any threads and torquing for final assembly. See steps 73-74 for installing the caliper mount.

25. Position the caliper bracket on the back side of the spindle. The raised boss on the spindle should align with the large hole in the bracket, and the countersunk holes on the bottom side of the bracket should align with the mounting holes in the spindle (Figure 23).



Figure 23

26. Insert a 1/2"-13 x 1.25" flat-head bolt into each of the countersunk holes on the bracket (Figure 24).



Figure 24

27. Insert a 1/2"-13 x 1.25" hex bolt into the upper mounting hole on the caliper bracket (Figure 25).

Torque the hardware to **90 ft-lbs.**

Repeat on the other spindle.



Figure 25

Spindle Installation

28. Position the spindle assembly onto the lower control arm ball joint (Figure 26).

Thread the castle nut onto the lower ball joint but do not tighten yet.

29. Pull the upper control arm down and insert the upper ball joint stud into the top of the spindle (Figure 27).

30. Thread the castle nut onto the upper ball joint and torque to **50 ft-lbs.**

Torque the lower ball joint nut to **65 ft-lbs.**

31. Install and bend the cotter pin for the upper and lower castle nuts (Figure 28).

If necessary, tighten the nut to line up the cotter pin holes.

Repeat steps 28-31 on the opposite side.



Figure 26



Figure 27



Figure 28

Steering Arms (11243796/97)

NOTE: For visual clarity and instructional purposes, Figures 29-31 are shown with the spindle off of the vehicle.

32. Insert a 90003535 threaded insert into each of the recessed openings at the bottom of the hub side of the spindle (Figure 29).

The inserts should be oriented with the threaded hole toward the bottom of the spindle.

33. Apply Loctite to two 1/2"-13 x 2" hex bolts and slide a 1/2" washer onto each bolt.

34. While holding the threaded inserts in place, flip the spindle over and align the holes in the steering arm with the holes in the threaded inserts.

The arm should curve toward the hub (outboard) side of the spindle (Figure 30).

The "appendage" of the arm should point to the front of the vehicle.

35. Insert a 1/2"-13 bolt with washer into each of the steering arm holes and thread into the inserts (Figure 31).

Torque to **90 ft-lbs.**

Repeat on the other spindle.



Figure 29

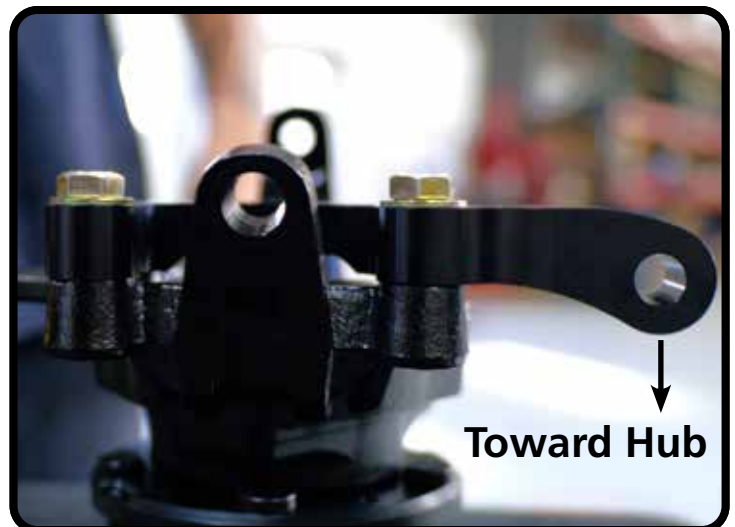

Figure 30



Figure 31

Steering Arms (11243798/99)

NOTE: For visual clarity and instructional purposes, Figures PS1-PS3 are shown with the spindle off of the vehicle.

PS1. From the "pin" side of the spindle, insert a 1/2" - 20 x 2.5" flat-head bolt into each of the two lowest holes on the spindle as shown in Figure PS1.

PS2. Rotate the spindle to the back side and slide the steering arm onto the 1/2" bolts.

The arm should curve toward the "pin" (outboard) side of the spindle (Figure PS2).

The "appendage" of the arm should point to the front of the vehicle.

PS3. Install a 1/2" washer and nylok nut onto each of the steering arm bolts (Figure PS3).

Torque to **100 ft-lbs.**

Repeat on the other spindle.



Figure PS1

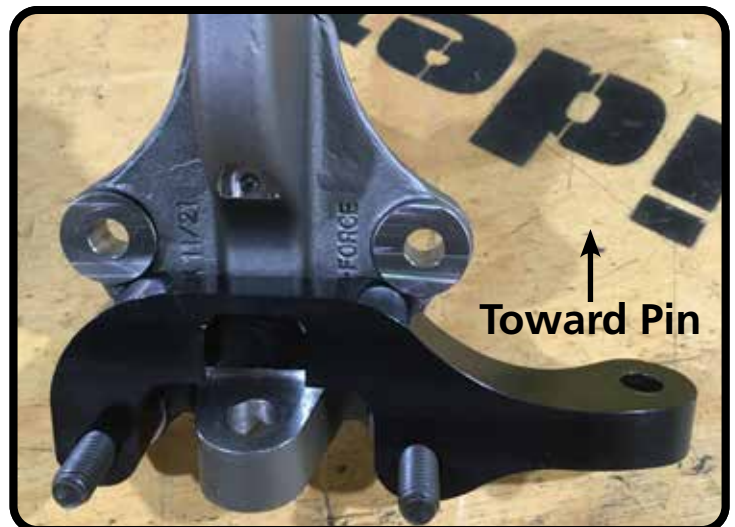

Figure PS2



Figure PS3

Steering Assembly

36. Thread a rod end onto the inner tie rod of the steering rack, and then insert the tie rod stud into the end of the steering arm from the bottom (Figure 32).



Figure 32

37. Thread the castle nut onto the stud and torque to **35 ft-lbs**.



Figure 33

38. Insert and bend the cotter pin (Figure 34).

It may be necessary to tighten the nut a bit more to line up the cotter pin holes.

Repeat steps 36-38 on the opposite side.



Figure 34

Front Sway Bar

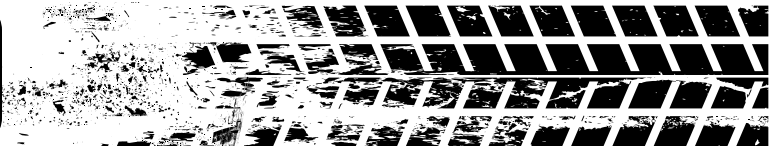

39. Spread open each of the 70015016 bushings at the split and install onto the sway bar (Figure 35).

NOTE: The bushings in this kit contain an anti-friction lining. No lubrication is required.

40. Slide a billet mounting strap over each bushing (Figure 36).

41. Rotate the straps/bushings so the flat side is facing up and position the bar under the front of the frame, aligning the mounting straps with the holes in the mounting flanges on the bottom of the frame rails (Figure 37).

A second set of hands may be helpful here.



Figure 35



Figure 36



Figure 37

Front Sway Bar

42. Insert a 3/8-16 x 1.25" bolt with washer into each of the billet strap mounting holes and secure with a 3/8" washer and nylok nut on each bolt (Figure 38). You may leave them hand tight for now to allow for easy bar articulation while installing the end links.

43. Slide an M12 flat washer onto each stud of the end link (Figure 39).

44. Insert one stud of the end link into the hole in the sway bar arm, and the other end link stud into the sway bar mounting flange on the front of lower control arm (Figure 40).



Figure 38

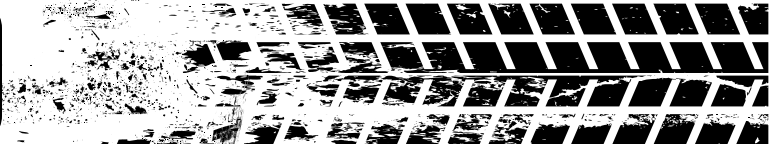

Figure 39



Figure 40

Front Sway Bar



45. Slide another M12 flat washer onto each end-link stud, followed by an M12 nylok nut.

Torque the M12 nuts to **85 ft-lbs**.

Repeat steps 43-45 on the opposite side.

46. Once the end links are installed, tighten the sway bar mounting straps bolts/nuts and torque to **32 ft-lbs** (Figure 42).

47. Install a 2-piece clamp collar on the inboard side of each sway bar mount (Figure 43).

The collar should be positioned against the bushing (Figure 44). Evenly tighten the two 1/4"-28 screws and torque to **13 ft-lbs**.



Figure 41



Figure 42



Figure 44



Figure 43

Upper 4-Link Bars

NOTE: If you have not already assembled the upper and lower 4-link bars, assemble them now. Refer to the "R-Joint Bar Assembly" instructions on page 49.

48. Insert a 70013334 spacer into each side of the R-Joint on one end of the upper 4-link bar as shown in Figure 45.

NOTE: The upper 4-link bar front mount has two mounting options, depending on how much anti-squat you desire. We recommend using the upper hole as the default position (Figure 46).

Refer to the table on page 40 for the correlating anti-squat values and how each position affects anti-squat relative to the lower 4-link bar position.

49. Position the R-Joint w/spacers into the upper 4-link bar front mount on the chassis (Figure 47).

Again, we recommend using the upper mounting hole as the default position.

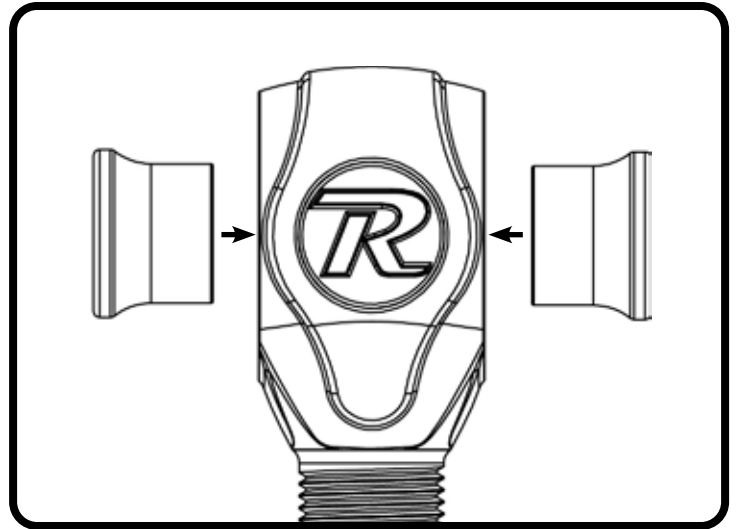

Figure 45

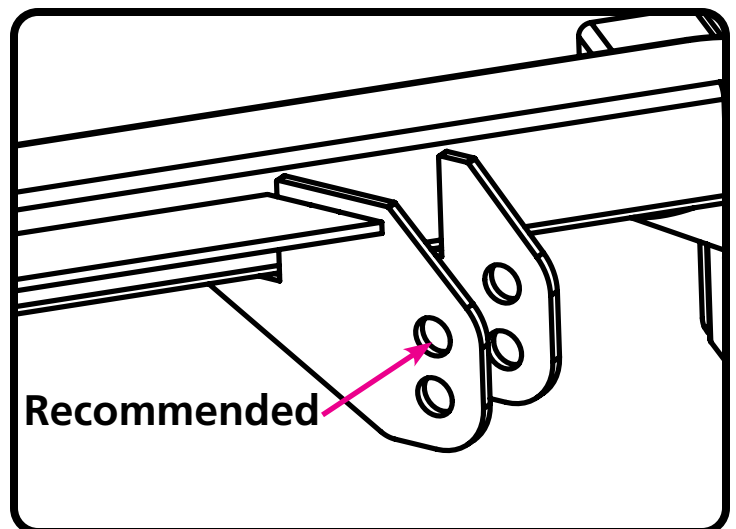

Figure 46



Figure 47

Upper 4-Link Bars

50. Insert a 5/8"-18 x 3" bolt with washer through the R-Joint & mount, and secure with a 5/8" washer & thin nylok nut (Figure 48). Do not tighten yet.

51. Insert a 70013334 spacer into each side of the R-Joint on the axle end of the upper 4-link bar and position the bar in the upper bar mount on the axle (Figure 49).

52. Insert a 5/8"-18 x 3" bolt with washer through the R-Joint & mount, and secure with a 5/8" washer & thin nylok nut (Figure 50).

Repeat steps 48-52 for the other upper bar.

Tighten all upper 4-link bar hardware enough to eliminate any gaps between the R-Joint spacers and the mounting flanges.



Figure 48



Figure 49



Figure 50

Rear Lower Shock Mount

53. Position the lower shock mount onto the axle bracket, aligning the top two holes in the aluminum mount with the top two holes in the bracket. This is the recommended setting for most people (Figure 51).

Using the lower two holes in the axle bracket will lower your vehicle an additional inch.

54. Insert a 1/2"-13 x 1.25" bolt in the top hole of the shock mount, and a 1/2"-13 x 1.75" bolt in the lower hole (Figure 52).

55. Install a 1/2" Nylok nut on each bolt and torque to **75 ft-lbs** (Figure 53).

56. Install a 5/8" washer on the lower shock mount stud, apply loctite to the threads, and thread into the bottom hole of the lower shock mount (Figure 54).

Torque the shock stud to **65-75 ft-lbs**.



Figure 51



Figure 52

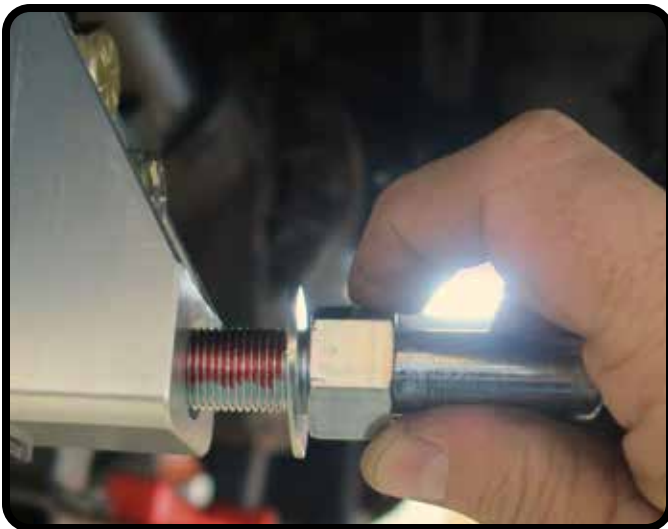
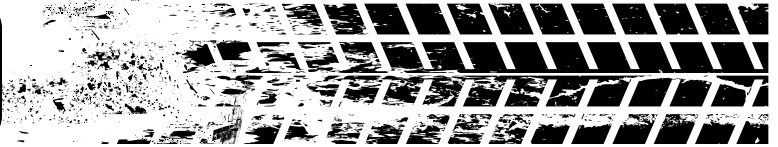

Figure 54



Figure 53

Lower 4-Link Bars



NOTE: The lower 4-link bar front and rear mounts each have three mounting options, depending on how much anti-squat you desire.

We recommend using the middle hole on each as the default position.

Refer to the table below for the correlating anti-squat values.

57. Insert a 70013334 spacer into each side of the R-Joint on one end of the lower 4-link bar and position the bar at middle hole of the front lower 4-link bar mount (Figure 55).

58. Insert a 5/8" -18 x 3" bolt with washer through the R-Joint & mount, and secure with a 3/8" washer & thin nylok nut (Figure 56). Do not tighten yet.



Figure 55



Figure 56

4-LINK BAR ANTI-SQUAT VALUES

LOWER BAR POSITION	UPPER 4-LINK BAR FRONT MOUNT POSITION	
	TOP HOLE*	BOTTOM HOLE
TOP HOLES	90%	175%
MIDDLE HOLES*	70%	135%
BOTTOM HOLES	55%	105%

*Recommended default setting (with lower bars level and eye-eye rear shock length of 14.5" at ride height)

Lower 4-Link Bars

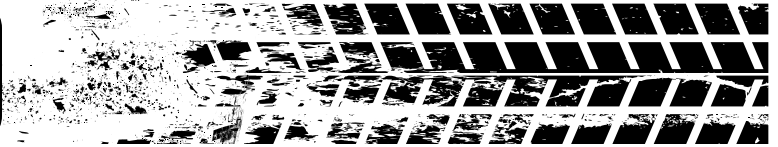

59. Insert a 70013334 spacer into each side of the R-Joint on the opposite end of the lower 4-link bar and position the bar in the middle hole of the rear lower bar mount (Figure 57).

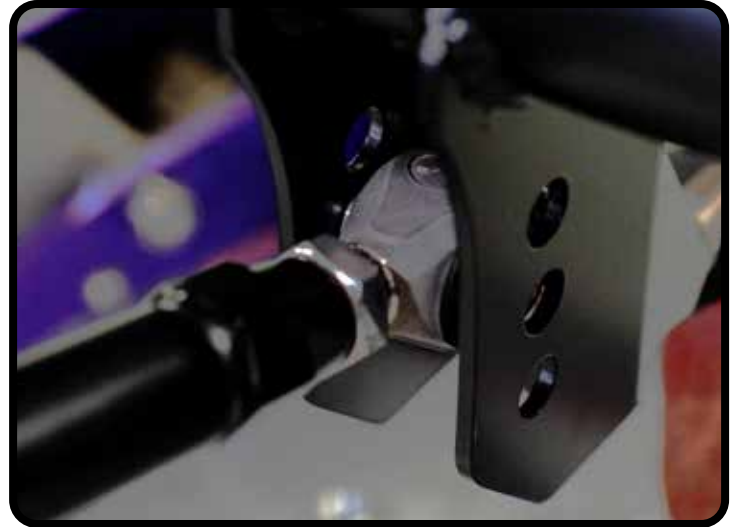

Figure 57

60. Insert a 5/8"-18 x 3" bolt with washer through the R-Joint & mount, and secure with a 3/8" washer & thin nylok nut (Figure 58).

Repeat steps 57-60 for the other lower bar.

Tighten all lower 4-link bar hardware enough to eliminate any gaps between the R-Joint spacers and the mounting flanges.

NOTE: This is a good time to install your rear Ridetech Coil-overs or Shockwaves (purchased separate). The mounting hardware is included in this kit (99010283).



Figure 58

Rear Coil-overs/Shockwaves

61. Insert a 90002043 spacer into each side of the bearing on the shock eyelet. The small end of the spacer will snap into the bearing (Figure 59).

62. Position the coil-over between the mounting flanges of the rear upper shock mount and align the holes (Figure 60).

NOTE: You may also install the shock inverted to provide easier access to the adjustment knob (coil-overs only).

63. Insert a 1/2" x 2.25" bolt through the bearing/mount and secure with a 1/2" washer and **thin** nylok nut (Figure 61).

Torque to **55 ft-lbs.**

64. Slide a 90002067 spacer onto the shock mount stud. The large end of the spacer will sit against the hex portion of the stud as shown in Figure 62.



Figure 59



Figure 60

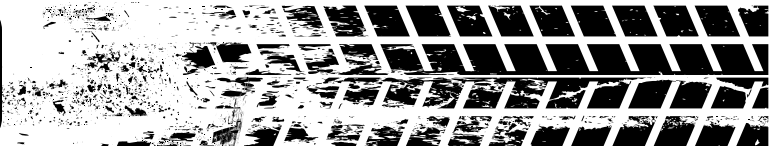

Figure 62



Figure 61

Rear Coil-overs/Shockwaves



65. Slide the coil-over onto the stud, followed by another 90002067 spacer. The small end of the spacer will snap into the bearing (Figure 63).

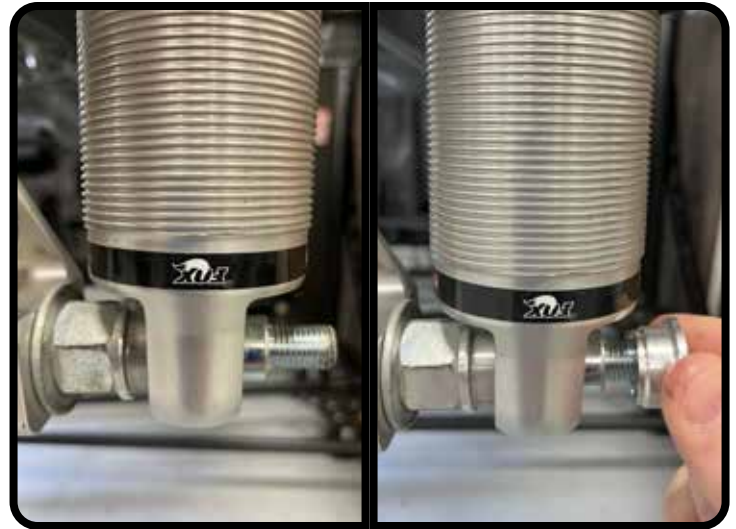

Figure 63

66. Install a 7/16" washer followed by a 7/16"-20 nylok nut and torque to **40 ft-lbs** (Figure 64).

Repeat steps 61-66 on the other side.



Figure 64

Option A. If you are using a lift and wish to install the engine/transmission and new chassis into the vehicle as an assembly, this is a good time to transfer your engine and transmission onto the new chassis. Once the transfer is complete, proceed to step 67 to install the transmission cross member. Do not forget to provide support for the transmission until the cross member is in place.

NOTE: We recommend not tightening the engine mount bolts until the entire assembly is in the vehicle and the engine is positioned where you want it.

Option B. If you do not have access to a lift and/or need to install the engine and transmission separately after the body is installed on the new chassis, skip to Chassis Installation on page 45. Once the new chassis is installed, you may circle back to Transmission X-Member.

Transmission X-Member

67. After transferring your engine and transmission onto the new frame, position the transmission cross member onto the set of mounting holes on the frame that align with the support flange on your transmission.

68. Bolt your transmission to the support plate on the transmission cross member. We recommend leaving the bolts hand tight until you have fine tuned the engine/transmission position in the vehicle.

NOTE: This cross member was designed to be compatible with most transmission mounts. We used the Energy Suspension 3.1108G transmission mount in our installation (Figure 67).

If you have something other than a T56 transmission, an optional spacer block (90003890) is included with this kit to help minimize the number of shims you may have to use. This spacer block should be used in conjunction with the Energy Suspension mount.

69. Attach the transmission cross member to the sub-frame with two 3/8"-16 x 1.25" bolts with washers on each side, secured with a 3/8" washer and nylok nut on each bolt.

We recommend leaving the bolts hand tight until you have fine tuned the engine/transmission position in the vehicle.



Figure 66

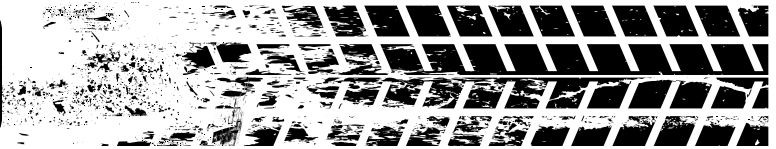

Figure 67



Figure 68

Chassis Installation



70. Position the new chassis under the vehicle and align the mounting locations on the chassis with their corresponding locations on the body.

NOTE: This step may be completed with or without the engine and transmission mounted in the chassis.

71. See the illustrations below for proper assembly/installation of the body mount bushings, sleeves, shims and hardware for each of the mounting types. Refer to Figure 69 on the next page for all mounting locations.

NOTE: Your particular application may not require the use of all 30 shims that are provided.

The mounts at location "A" will use the longer 7/16"-14 x 3" bolts with nylock nuts, and all other mounting locations "B" will use 7/16"-14 x 2.25" bolts that thread into the body. If slightly longer bolts are required, we have also included a set of 7/16"-14 x 2.50" bolts for the "B" locations.

The mounts at location "B-1" are not commonly used in most applications. Please contact Ridetech if your vehicle requires bushings for this location.

Torque location "A" bolts to **45 ft-lbs.**
 Torque location "B" bolts to **70 ft-lbs.**

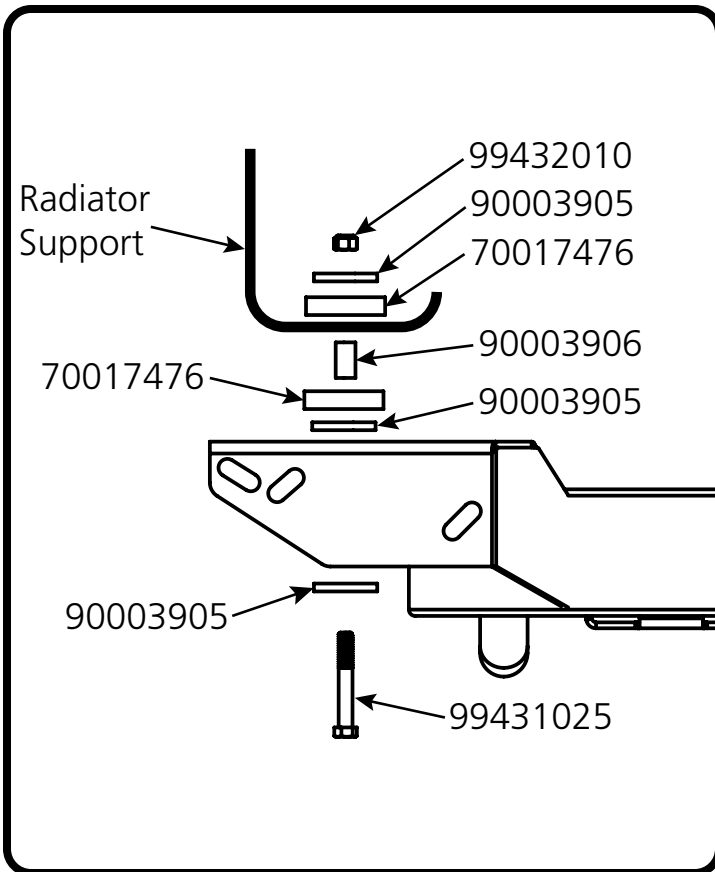

Location "A" Body Mounts

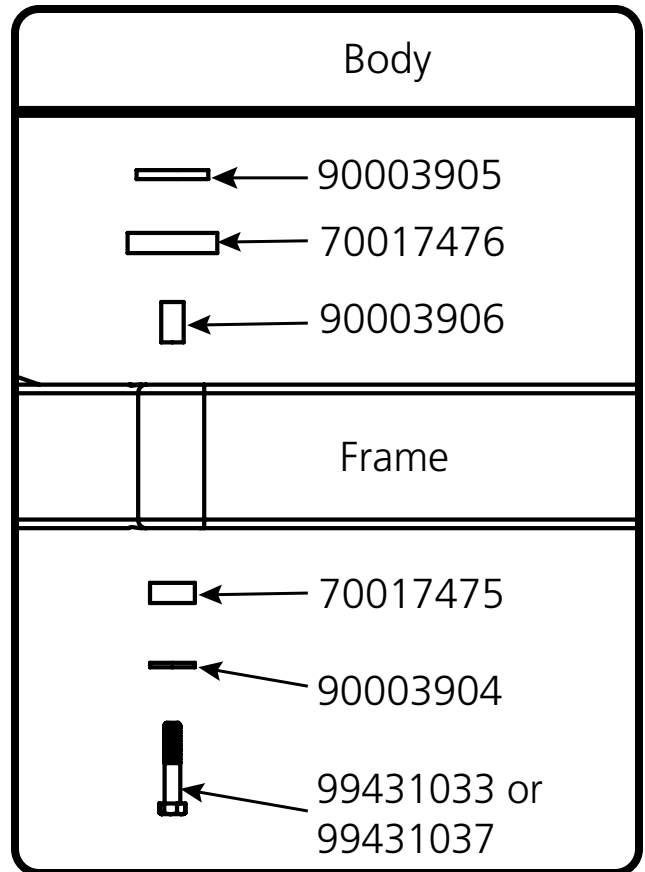

Location "B" Body Mounts

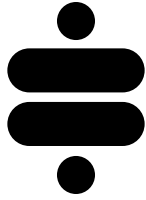

Mounting Locations

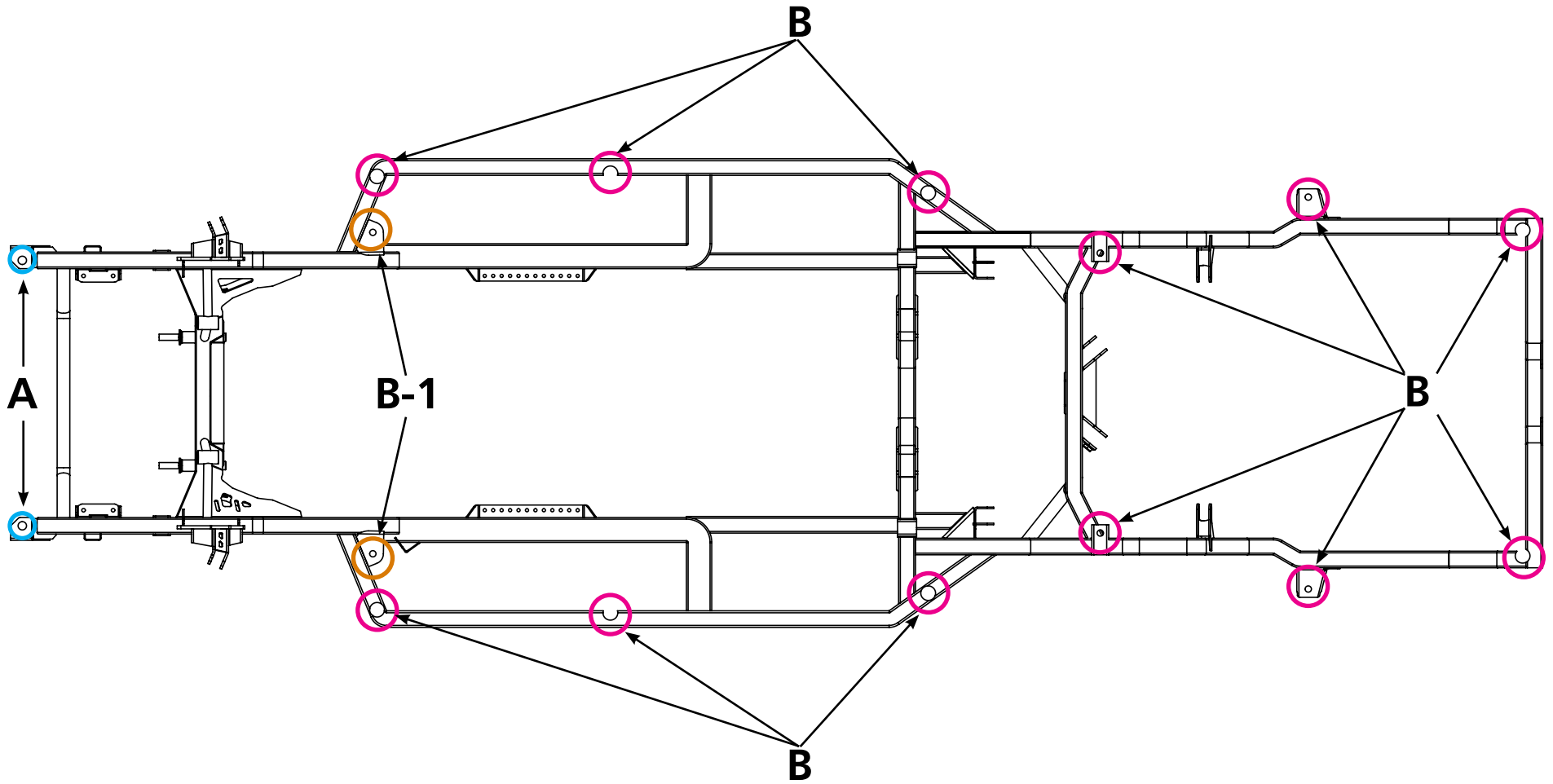

Figure 69

Final Assembly

72. With the body, engine and transmission installed on the chassis, make any final adjustments to the position of the engine/transmission. Once satisfied, tighten the four 3/8" Transmission X-Member bolts (Figure 70). Torque to **32 ft-lbs**.

Do not forget to also tighten the engine mount bolts.

73. Reinstall/reattach the driveshaft, engine accessories, lines, hoses, wiring harnesses, etc.

74. Finish installing the brakes. Install the brake rotor and temporarily secure with a couple of lug nuts (Figure 71).

75. (11243796/97 Only) Mount the brake caliper mount to the caliper bracket with (2) M14-2.0 x 45mm bolts and M14 washers. Insert a 90003549 spacer on each bolt, between the caliper bracket and the caliper mount (Figure 72). Torque to **125 ft-lbs**.

76. Install the brake calipers and pads.

77. Finish plumbing and bleeding the system.

NOTE (11243796/97): This kit includes a set of shims to aid in centering the caliper mount on the rotor. The provided shims are in three different thicknesses (.016", .032", .063").

- To push the caliper mount outward, insert 5/8" shim washers between the caliper and the caliper bracket.
- To pull the caliper mount inward, insert 1/2" shim washers on the bolts from steps 29 & 30, between the caliper bracket and the spindle.

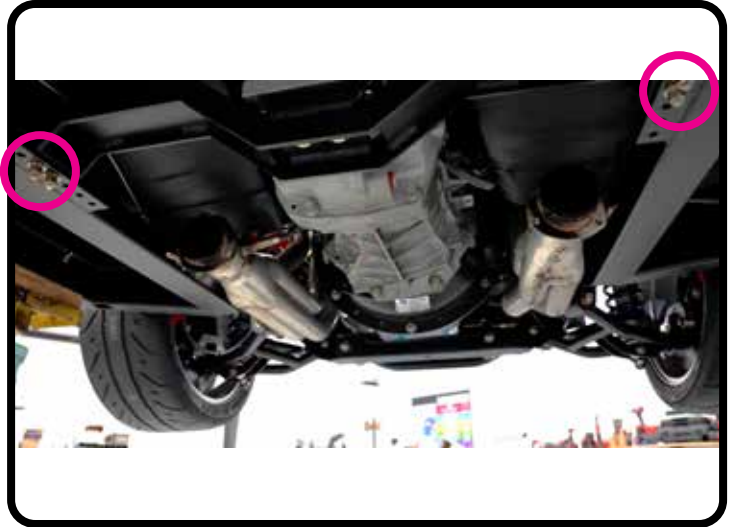

Figure 70



Figure 71

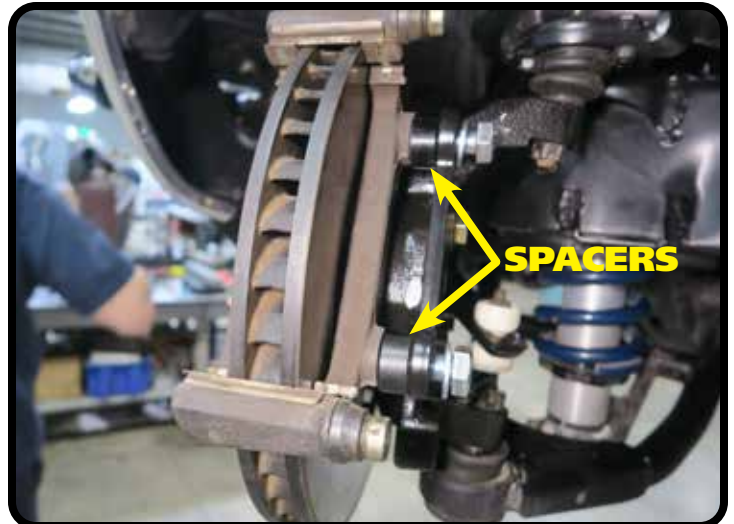
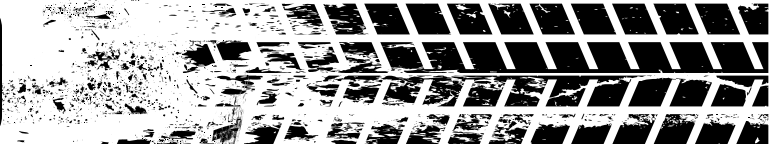

Figure 72

Final Assembly



78. Reinstall the hood, bumper, wheels/tires, etc. Then set the vehicle on the ground.

NOTE: This kit includes captured nuts (90003650) for attaching the front bumper to the new frame. See the illustration below. Slide the nut into the "cage" on the frame rail, and then attach the bumper by threading the OEM mounting bolt through the bumper and into the captured nut. The "cage" is slotted to allow for adjustment.

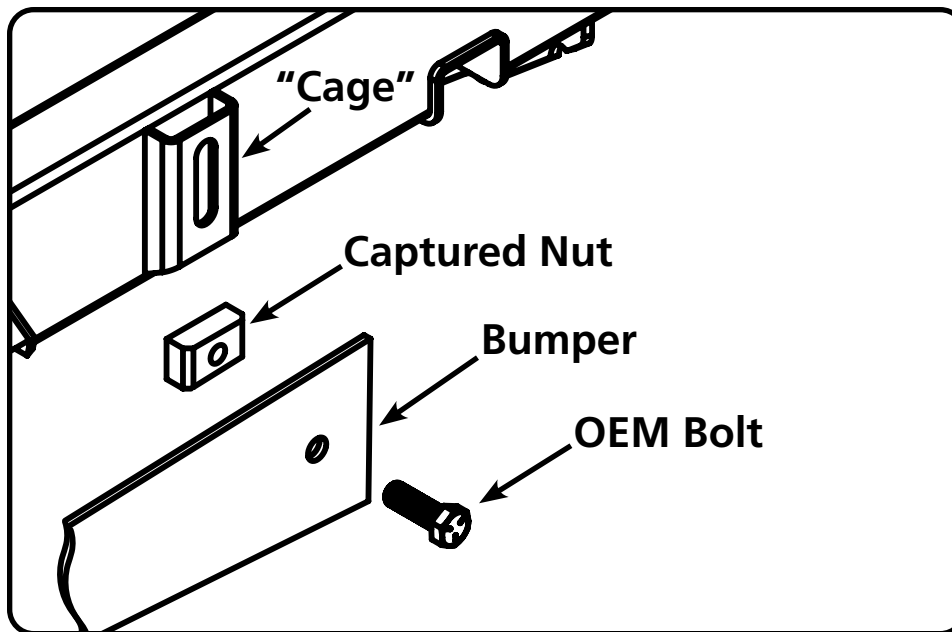

79. If you're running coil-overs, adjust and set your ride height. See the "Adjusting Ride Height Guide" in your coil-over instructions.

If you're on air, finish plumbing and testing the system.

80. Have the vehicle aligned. See the recommended alignment specs below.

Suggested Alignment Specs For Street Driving

Camber: -.5 Degrees

Caster: +3.0 to +5.0 Degrees

Toe: 1/16" - 1/8" Toe In

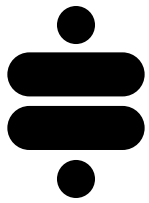

R-Joint Bar Assembly

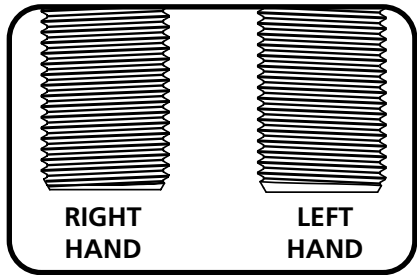
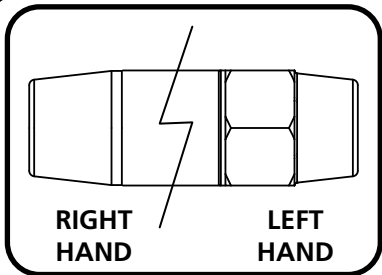
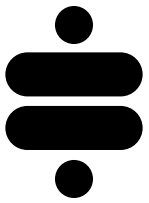

THE 4-LINK BARS, R-JOINTS, AND JAM NUTS HAVE RIGHT HAND AND LEFT HAND THREADS. THIS ALLOWS THE BAR TO BE ADJUSTED WITHOUT REMOVING IT. THE HEX END OF THE BAR IS LEFT HAND THREAD. THE LEFT HAND JAM NUT HAS AN COUNTERCLOCKWISE ARROW STAMPED INTO IT. IMAGE 3 WILL HELP YOU DETERMINE THE THREADS OF THE R-JOINTS.

- RJa.** Component List:
1. 4-Link Bar
 2. Right Hand Thread R-joint
 3. Right Hand Thread Jam Nut
 4. Left Hand Thread R-Joint
 5. Left Hand Thread Jam Nut

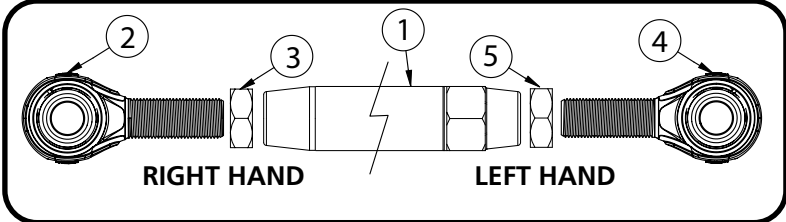

RJb. Thread the jam nuts onto the threaded shank of the r-joints. Thread the nuts all the way on to the r-joint.

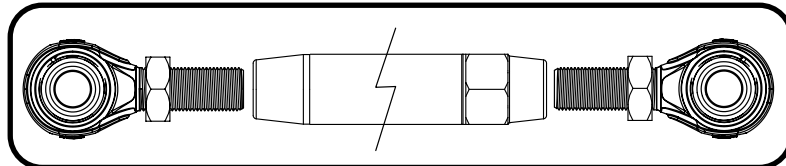

RJc. *Apply anti-seize to the threads of the r-joint.* This will prevent the threads from galling.



RJd. Thread the r-joints into the 4-link bar. Thread them in evenly until you achieve the correct center-to-center length.

Upper Bar Length: 10 5/8"
Lower Bar Length: 21 3/4"

Nominal R-Joint Threads Exposed: 1/4"
Maximum R-Joint Threads Exposed: 5/8"

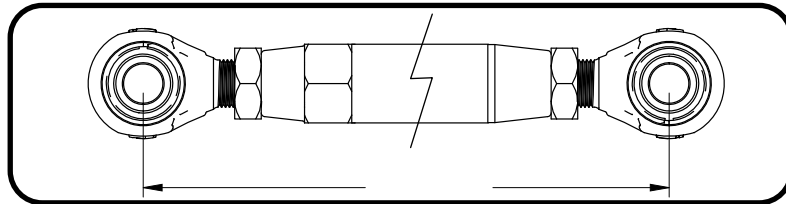

RJe. After getting one bar length set, you can put a 5/8" bolt through the r-joints to simplify setting the next bar. Adjust the bar length of the 2nd bar until it will slip on and off the bolts. Torque the jam nuts 65-75 ft-lbs using an 1 1/8" crows foot on a torque wrench.

