



Part # 11306210 - 1967-1970 GM "B" Body Rear CoilOver System

Kit Components:

- 11286210 Rear CoilOver Kit Includes:
Rear Lower StrongArms
Rear CoilOvers
- 11306698 Rear Upper StrongArm
- 11289000 Rear Adjustable Panhard Kit

Recommended Tools

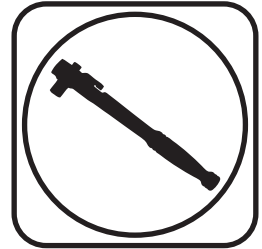

1967-1970 GM "B" Body CoilOver Installation Instructions

Table of contents

- Pages 2-9..... Lower CoilOver StrongArms
- Pages 10-12..... Upper StrongArms
- Pages 13-16..... Adjustable PanHard Bar
- Pages 17-20..... Rear CoilOvers

Some vehicles have two factory upper arms and need a second tubular arm, Kit # 11306698.





Part # 11286299 - 1965-1970 Full Size Chevy Rear CoilOver StrongArms

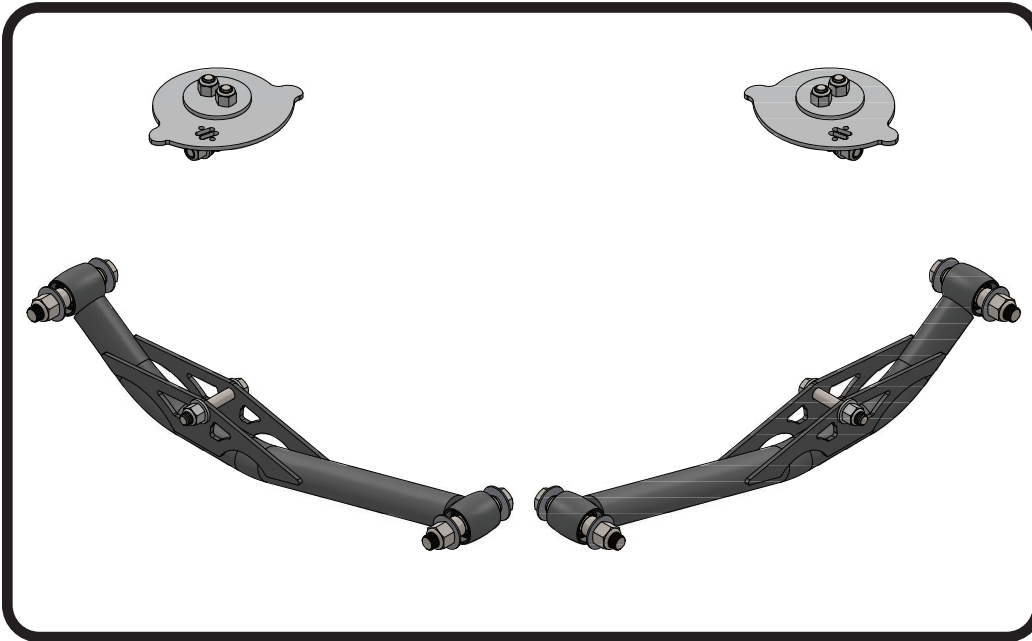

Recommended Tools

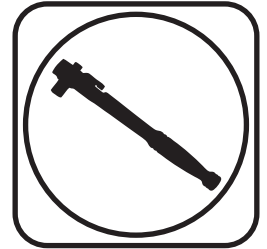

1965-1970 GM "B" Body Rear CoilOver StrongArms

Installation Instructions

Table of contents

Page 3.....	Included Components
Page 4.....	Hardware & Getting Started
Page 5-6.....	Upper Mount Installation
Page 7-8.....	Lower StrongArm Installation
Page 8-9.....	CoilOver Installation





Included ComponentsIn the box

Item #	Part #	Description	QTY
1	90003179	Lower Control Arms	2
2	90003180	Upper Mount base plate	2
3	90002158	Universal Shock Mounting Bracket	2
4	90001357	Upper Clamp Plate	2
5	70013858	R-Joint Spacers - .625" ID x 1.00"	8
R-Joint Components - (Installed in bar ends)			
6	70013279	Retaining Ring	4
7	70013280	Wavo Wave Spring	4
8	70013275	R-Joint Center Ball	4
9	70013276	R-Joint Composite Center Ball Cage	4

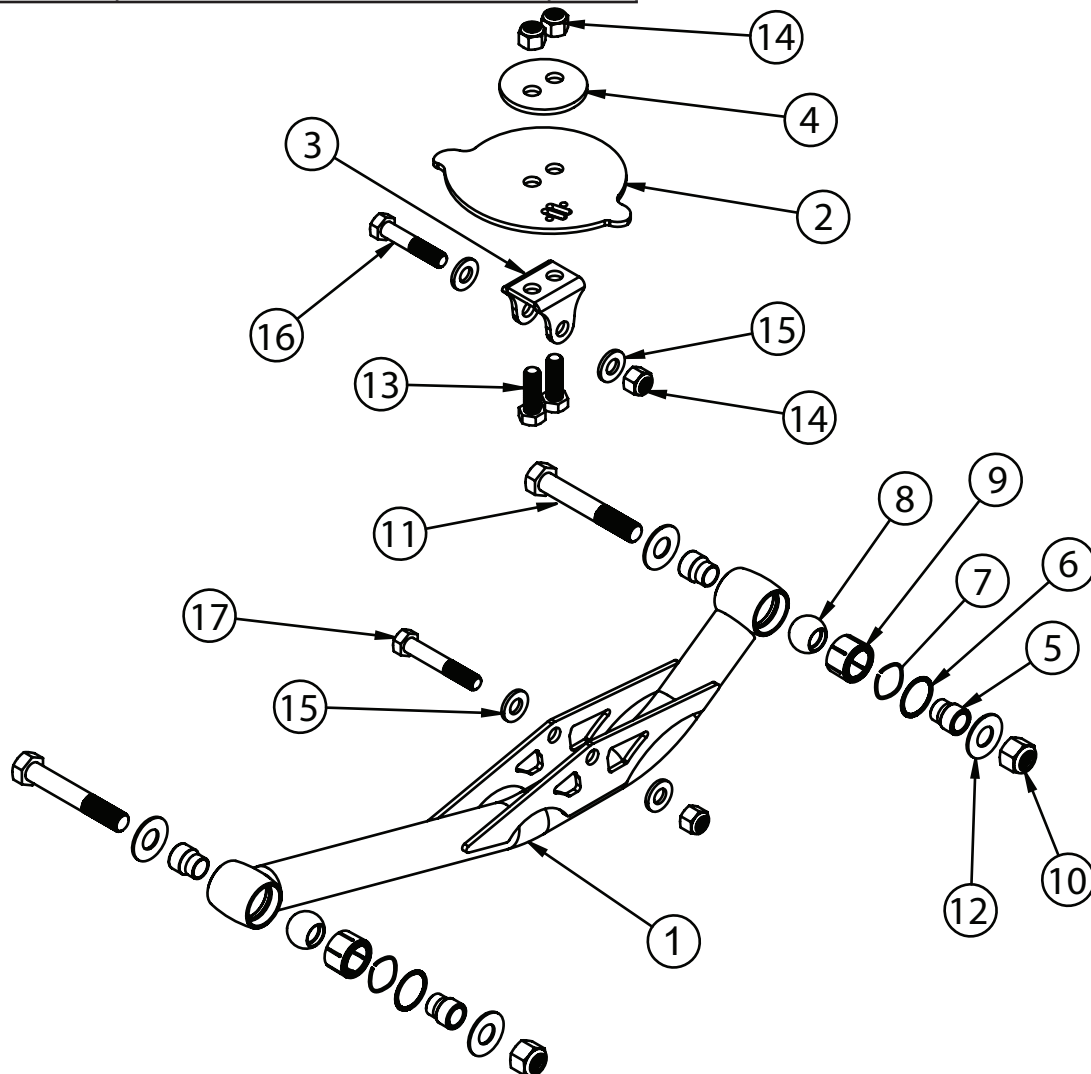



Hardware Kit..... #99010134

Item #	QTY	Part Number	Description	Item #	QTY	Part Number	Description
REAR UPPER CONTROL ARM				REAR COILOVER MOUNTING			
10	4	99622001	5/8"-18 Nylok Nut	14	4	99502009	1/2"-13 Nylok Nut
11	4	99621010	5/8"-18 x 4" Hex Bolt	15	8	99503014	1/2" SAE Flat Washer
12	8	99623001	5/8" SAE Flat Washer	16	2	99501050	1/2"-13 X 2 1/2" Hex Bolt
REAR UPPER SHOCK MOUNT				17	2	99501064	1/2"-13 X 2 3/4" Hex Bolt
13	4	99501053	1/2"-13 X 1 1/2" Hex Bolt				
14	4	99502009	1/2"-13 Nylok Nut				

R-JOINT SPACER INSTALLATION

Install the Spacers by inserting the SMALL side of the SPACER into the Center Pivot Ball. Push them in until they bottom out and stop.

LOWER R-JOINTS

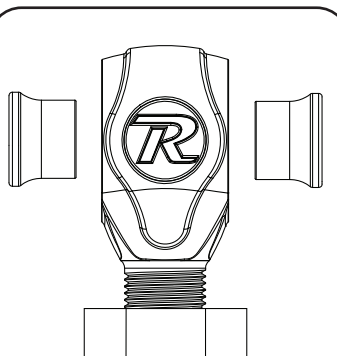

New R-Joints will be quite stiff (75-90 in/lbs breakaway torque) until they "break in" after a few miles of use. After the break in period they will move much more freely. Because the composite bearing race contains self lubricating ingredients, no additional lubrication is needed or desired. Any additional lubrication will only serve to attract more dirt and debris to the R-Joint and actually shorten its life.

Getting Started.....

Congratulations on your purchase of the Ridetech B-Body CoilOver StrongArms. These StrongArms have been designed to give your B-Body excellent handling along with a lifetime of enjoyment. Some of the key features of the StrongArm System: The StrongArms are designed to utilize a CoilOver Shock setup, R-Joints are used to eliminate bushing deflection along with providing free suspension movement through the entire travel. The R-Joints are made from a material that is self lubricating so no lubrication is needed.

Note: These control arms are designed for use with the Ridetech CoilOvers and the MuscleBar swaybar. **The factory shocks and springs will not fit these StrongArms. If you have a swaybar that attaches to the lower control arms, it will NOT work with these StrongArms.**

1. Raise the vehicle up to a comfortable work height. You will need the support the car by the frame to be able to freely raise and lower the rear axle. Use a jack under the differential to support it.
2. Remove the rear shocks, coil springs, and lower control arms.



Upper Mount Installation

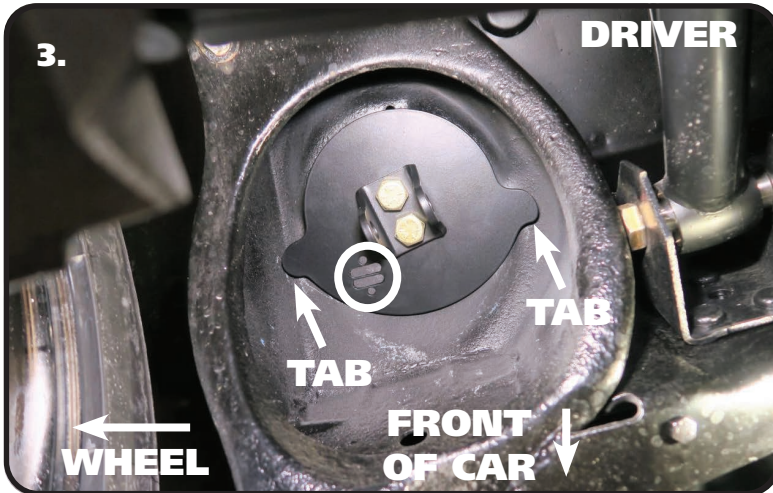

3. This kit contains a Upper Shock Mount setup that is designed to be mounted in a specific orientation. **Image 3** illustrates the proper orientation of the upper mount, we will cover the installation in the next steps. The upper mount is installed in the OEM coilspring pocket with the TABS of the upper plate to the front of the car. The Ridetech Icon(CIRCLED) needs to be toward the wheel. See **Image 3**.



4. The Upper Clamp Plate needs to be placed on the top side of the OEM coilspring pocket. It will fit down in the recessed area of the coilspring pocket. Use **Images 4 & 5** as a reference to install the upper clamp plate.

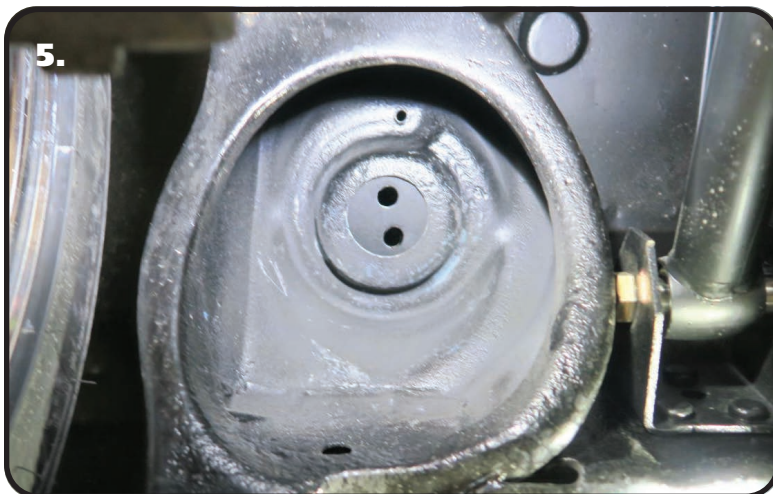

5. **Image 5** shows the Upper Clamp Plate in position as looking at it from the bottom side of the frame. Don't worry about the orientation of the bolt holes. You will position it correctly during the installation of the Upper Shock Mount.



Upper Mount Installation

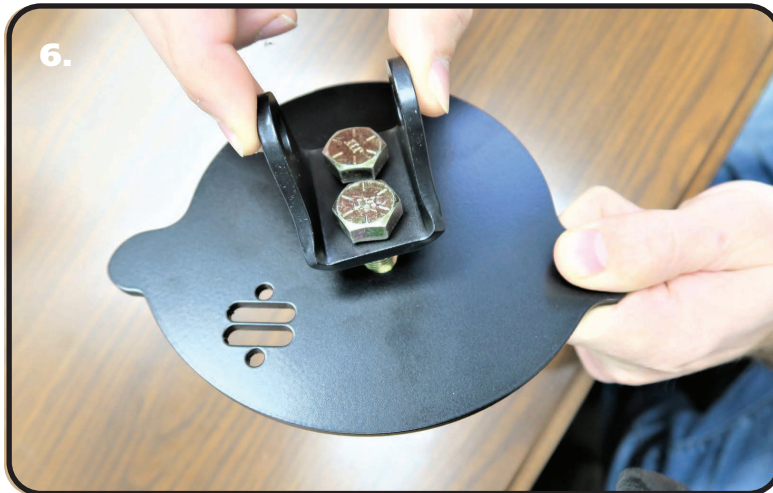

6. The Upper Mount Assembly is attached to the frame using (2) 1/2"-13 x 1 1/2" Bolts. Insert the bolts through the shock mount and through the upper plate.



7. Position the Shock Mount/Plate up into the frame, holding the shock mount and hardware in place. **Position the mount with the tabs to the front of the car and Ridetech Icon toward the wheel.** You will need to align the upper clamp plate with the bolts that are sticking up through the frame.



8. Install a 1/2"-13 nylok nut on each of the bolts sticking through the frame and upper clamp plate. Torque the hardware to 75 ftlbs. Repeat for the second side of the car.



Lower StrongArm Installation



9. The Lower Control Arm has the bottom CoilOver mount built in. It will need to be installed with the CoilOver mount up and to the rear of the car. Install a 5/8" ID R-joint Spacer into the front R-joint. The Small Diameter goes into the R-joint. Slide the R-joint into the OEM lower control arm mount. Align the holes in the frame with the thru-hole of the R-Joint.

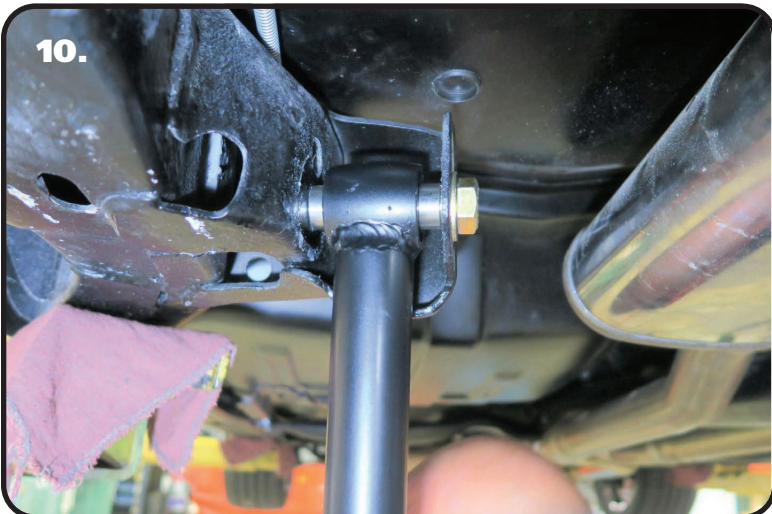

10. Install a 5/8" Flat Washer on a 5/8"-18 x 4" bolt. Insert the bolt/washer into the frame/R-Joint of the lower bar. Install a 5/8" flat washer and 5/8"-15 nylok nut on the threads of the bolt sticking through the frame. Tighten the hardware to eliminate any gaps.

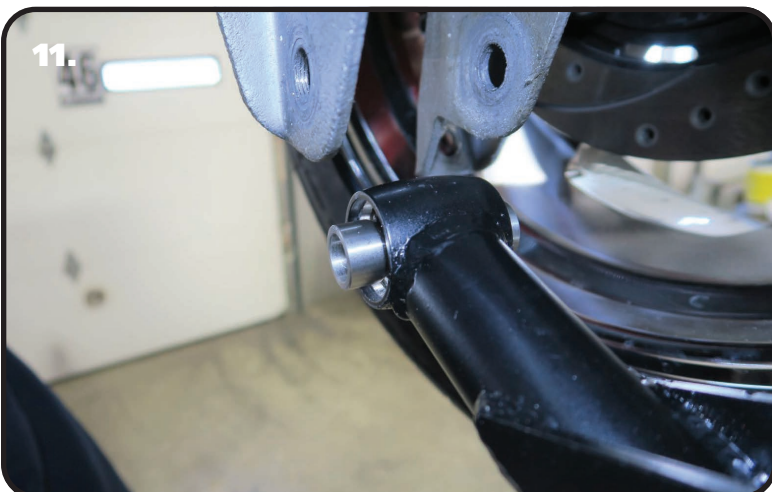

11. Install the R-joint spacers into the rear R-Joints. Slide the rear of the lower control arm into the axle mount. Line up the mounting holes in the axle mount with the thru-hole of the R-joint.



Lower StrongArm & Shock Installation



12. Install a 5/8" flat washer on a 5/8"-18 x 4" bolt. Insert the bolt/washer through the mounting hole. Install a 5/8" flat washer and 5/8"-15 nylok nut on the threads of the bolt sticking through the axle mount. Tighten the hardware to eliminate any gaps



13. Refer to the CoilOver instructions that are included with the CoilOvers for proper CoilOver assembly. Insert the SHORT shock bearing t-bushings into the bearing of the **shock body**. The SMALL diameter of the t-bushings will insert into the shock bearing.



14. Insert the shock into the upper mount, lining up the holes of the mount and shock bearing/spacers. Install a 1/2" flat washer on a 1/2"-13 x 2 1/2" bolt. Insert the bolt/washer into the upper mount/shock. Install a 1/2" flat washer and 1/2"-13 nylok nut and Torque to 50 ftlbs.

Note: For ease of adjustment, the shock needs to be mounted with the shock body up.



Shock Installation

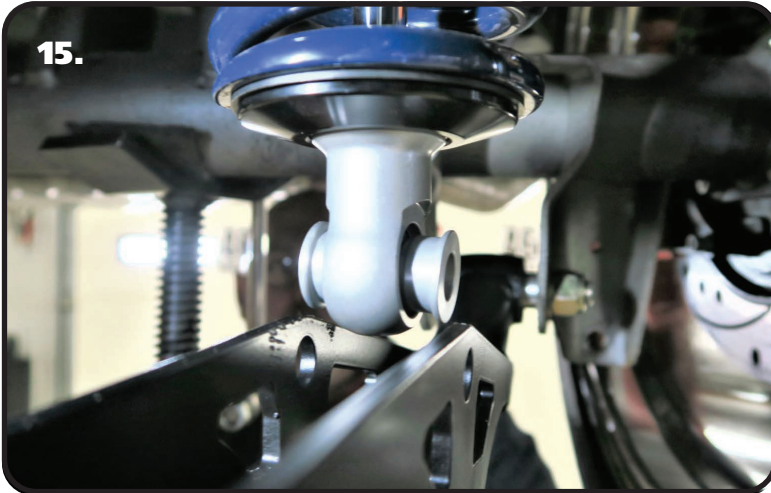

15. Insert the LONG shock bearing t-bushings into the bearing of the shock eyelet. The SMALL diameter of the t-bushings will insert into the shock bearing.



16. Insert the shock into the lower control arm with the adjuster knob to the front of the car. Line up the holes of the mount and shock. Install a 1/2" flat washer on a 1/2"-13 x 2 3/4" bolt. Insert the bolt/washer into the upper mount/shock. Install a 1/2" flat washer and 1/2"-13 nylok nut and Torque to 50 ftlbs.

Note: If the shock knob is not facing the correct direction, you can turn it as needed.



Part # 11306698 - 1967-1970 Full Size Chevy Rear Upper StrongArm Kit

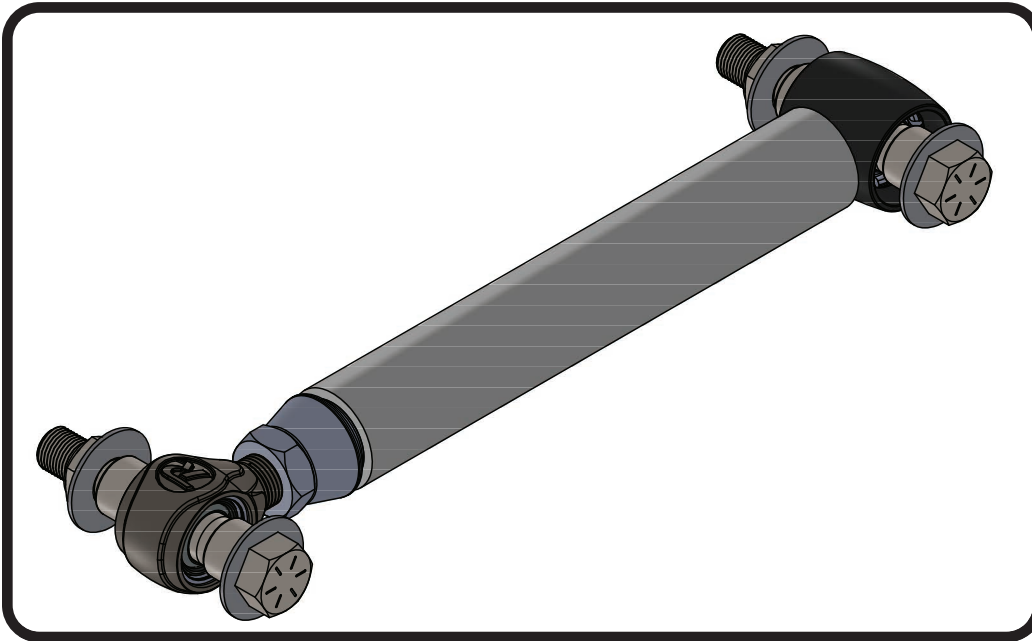

Recommended Tools

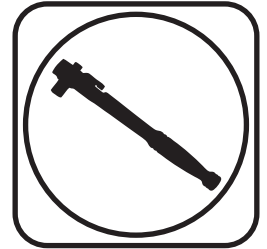

1967-1970 GM "B" Body Rear Upper StrongArms Installation Instructions

Table of contents

Page 11..... Included Components
Page 12..... Installation

Some vehicles have two factory upper arms and need a second tubular arm, Kit # 11306698.





Included ComponentsIn the box

Item #	Part #	Description	QTY
1	90002851	Upper StrongArm - set to 10.00"	1
2	70013544	R-Joint Spacers	4
3	90001318	Standard 3/4"-16 R-Joint	1
4	99752004	3/4"-16 Jam Nut	1
R-Joint Components - (Installed in bar ends)			
5	70013279	Retaining Ring	1
6	70013280	Wavo Wave Spring	1
7	70013275	R-Joint Center Ball	1
8	70013276	R-Joint Composite Center Ball Cage	1

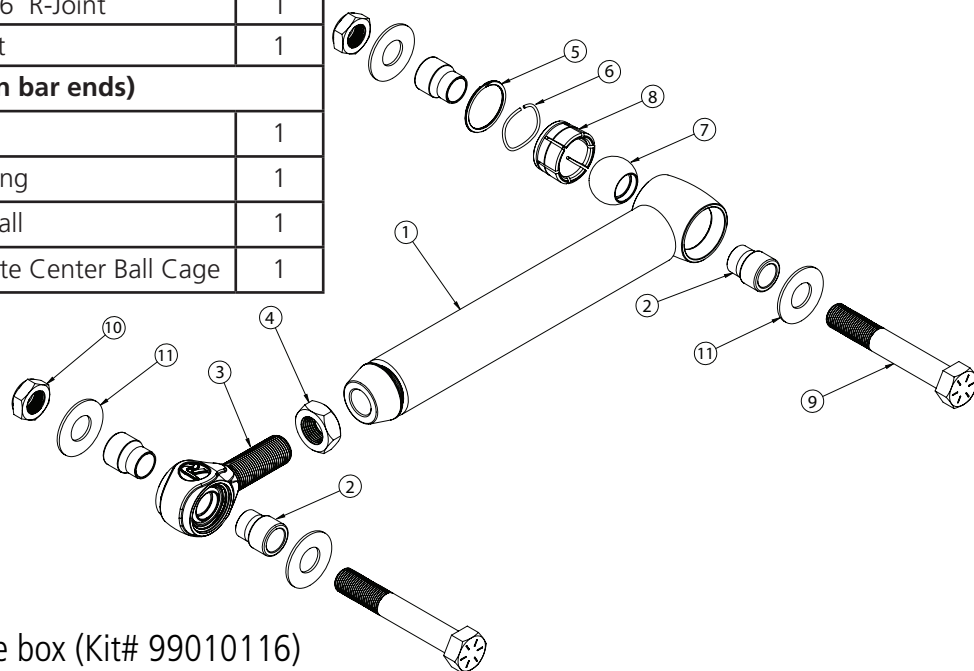

Hardware ListIn the box (Kit# 99010116)

Item #	QTY	Part Number	Description
REAR UPPER CONTROL ARM			
9	2	99621010	5/8"-18 x 4" Bolt
10	2	99622006	5/8"-18 Nylok Nut
11	4	99623001	5/8" SAE Flat Washer

R-JOINT SPACER INSTALLATION

Install the Spacers by inserting the SMALL side of the SPACER into the Center Pivot Ball. Push them in until they bottom out and stop.

UPPER R-JOINTS

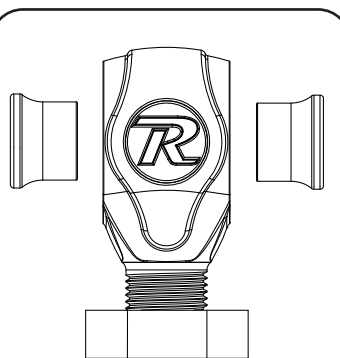

New R-Joints will be quite stiff (75-90 in/lbs breakaway torque) until they "break in" after a few miles of use. After the break in period they will move much more freely. Because the composite bearing race contains self lubricating ingredients, no additional lubrication is needed or desired. Any additional lubrication will only serve to attract more dirt and debris to the R-Joint and actually shorten its life.



Upper Bar Installation

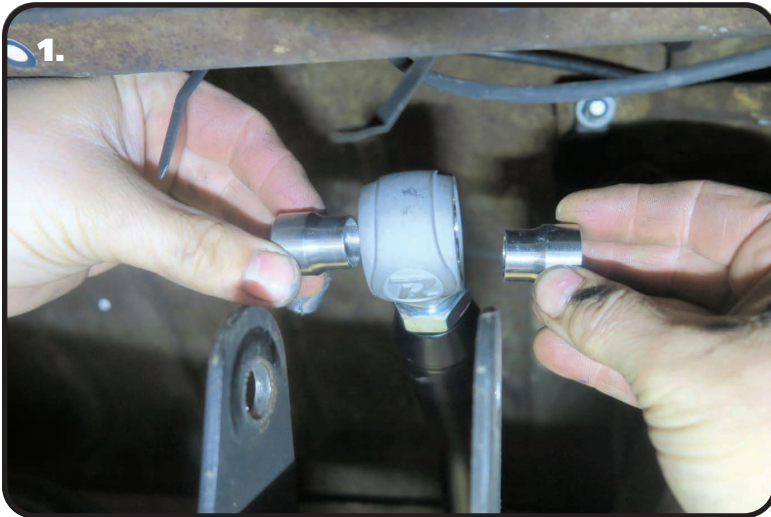

1. Insert the small diameter of the R-Joint Spacers into the center ball of the R-Joint. Insert the R-Joint/Spacers into the OEM mount of the differential.

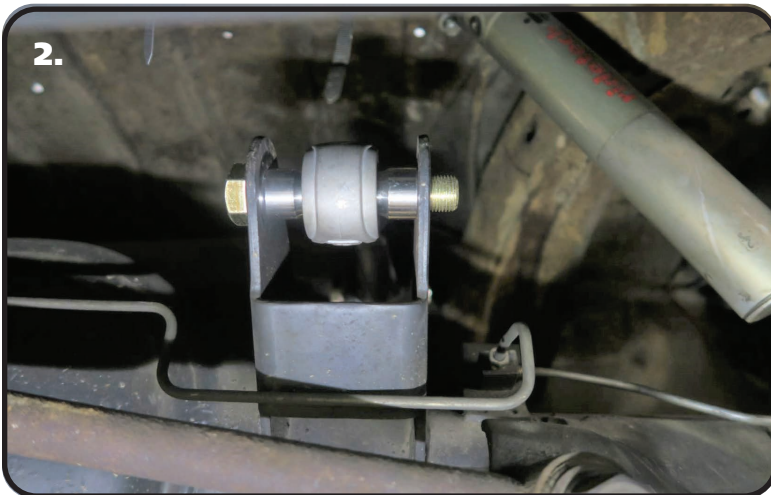

2. Install a 5/8" flat washer on a 5/8"-18 x 4" hex bolt through the mount and control arm R-Joint. Install a 5/8" flat washer, followed by a 5/8"-18 nylok jam nut onto the threads of the bolt. Tighten the hardware enough to eliminate any gaps.

REPEAT THE ABOVE STEPS FOR THE FRAME SIDE OF THE UPPER STRONG ARM.



Part # 11289000 - 1965-1970 Full Size Chevy Adjustable Panhard Kit

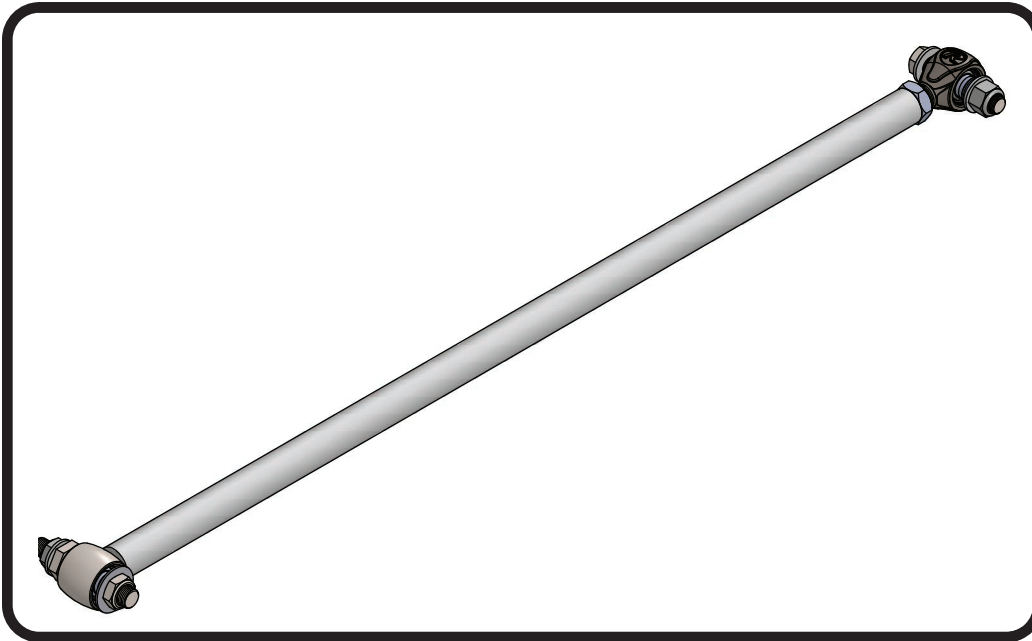

Recommended Tools



1965-1970 GM "B" Body Adjustable Panhard Kit Installation Instructions

Table of contents

Page 14..... Included Components & Hardware
Page 15-16..... Installation





Included ComponentsIn the box

Item #	Part #	Description	QTY
1	90002827	Panhard Bar - set to 35.750"	1
2	90000461	Panhard Stud	1
3	70013334	R-Joint Spacers - Stud	2
4	90001318	Standard 3/4"-16 R-Joint	1
5	99752004	3/4"-16 Jam Nut	1
6	70013764	R-Joint Spacers - Frame	2
R-Joint Components - (Installed in bar ends)			
7	70013279	Retaining Ring	1
8	70013280	Wavo Wave Spring	1
9	70013275	R-Joint Center Ball	1
10	70013276	R-Joint Composite Center Ball Cage	1

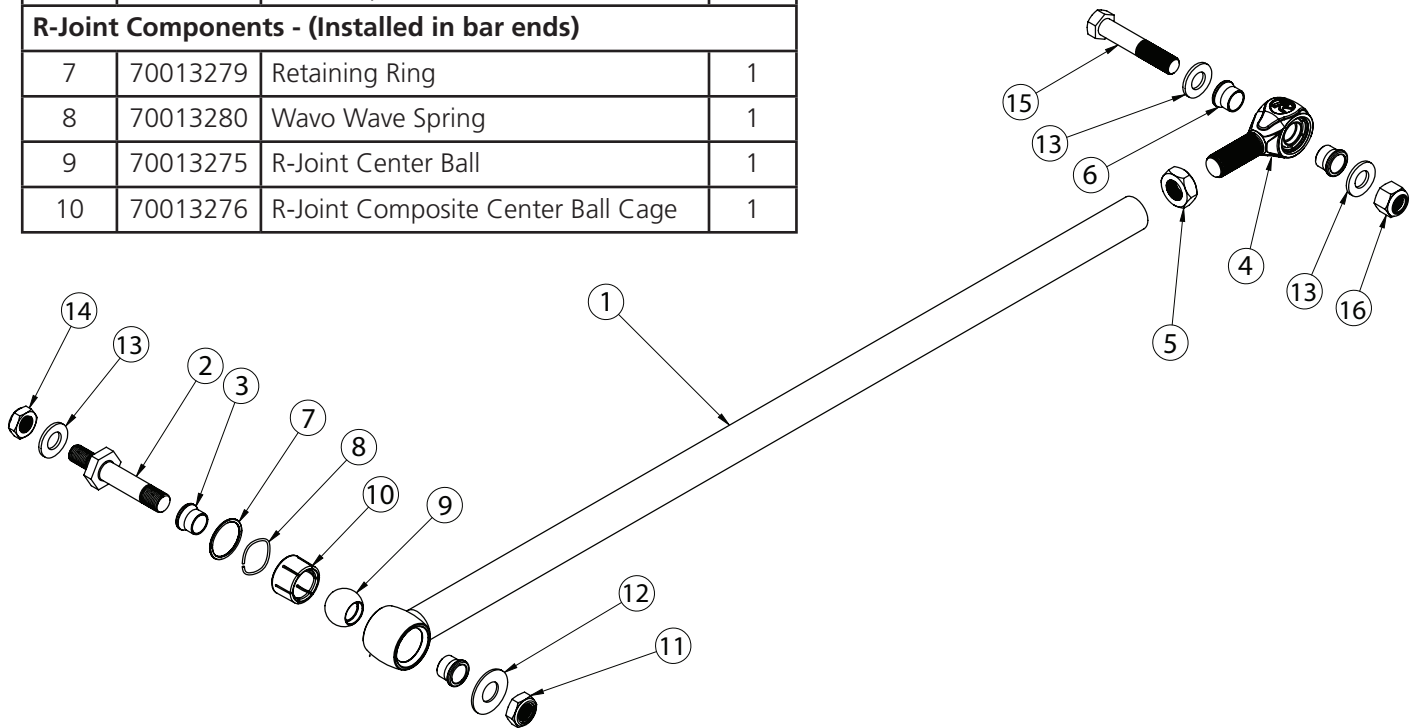

Hardware ListIn the box (Kit# 99010123)

Item #	QTY	Part Number	Description
PANHARD BAR STUD			
11	1	99622006	5/8"-18 Nylok Jam Nut
12	1	99623001	5/8" SAE Flat Washer
13	1	99566003	9/16" SAE Flat Washer
14	1	99562001	9/16"-18 Nylok Nut
PANHARD BAR FRAME MOUNT			
13	2	99566003	9/16" SAE Flat Washer
15	1	99561003	9/16"-18 x 3" Bolt
16	1	99562003	9/16"-18 Nylok Jam Nut



R-Joint Spacer Installation

R-JOINT SPACER INSTALLATION

Install the Spacers by inserting the SMALL side of the SPACER into the Center Pivot Ball. Push them in until they bottom out and stop.

UPPER R-JOINTS

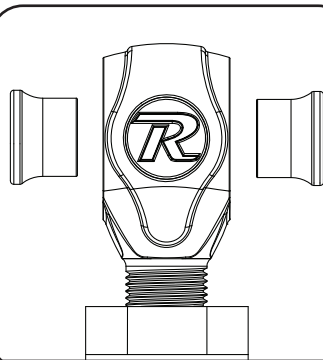

New R-Joints will be quite stiff (75-90 in/lbs breakaway torque) until they "break in" after a few miles of use. After the break in period they will move much more freely. Because the composite bearing race contains self lubricating ingredients, no additional lubrication is needed or desired. Any additional lubrication will only serve to attract more dirt and debris to the R-Joint and actually shorten its life.

The Panhard bar can be removed from the car with it sitting at any height, but the car will need to be at ride height when checking the sided to side dimensions. It may be necessary to adjust the panhard bar to center the differential in the car at ride height.

1. Remove the OEM panhard bar from the car.
2. Remove the panhard bar stud from the rear differential.

Panhard Bar Installation



1. Bolt the new panhard bar stud into the OEM location of the axle using the 9/16" flat washer and 9/16"-18 Nylok nut supplied in the kit. Torque to 95 ftlbs.



Panhard Bar Installation



2. Install a Narrow 5/8" ID R-joint Spacers into each side of the R-joint of either end of the Panhard Bar. The Small Diameter goes into the R-joint. Slide the R-joint onto the stud and fasten in place with a 5/8" flat washer and 5/8"-18 thin jam nylok nut. Torque to 95 ftlbs.

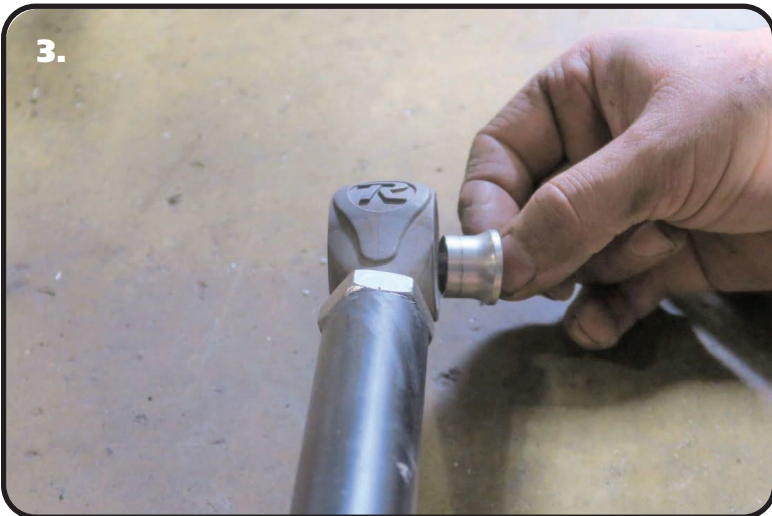

3. Install the 3/4" jam nut onto the end of the R-Joint end, then screw R-Joint end into the end of the panhard bar. Set the Panhard Bar to 35.750". You may need to readjust it after getting the car set at ride height, but this is a good starting point. Press the SMALL diameter of the 9/16" I.D. R-Joint spacers into each side of the center ball of the remaining R-Joint. Push the spacers in until they bottom out in the center ball.

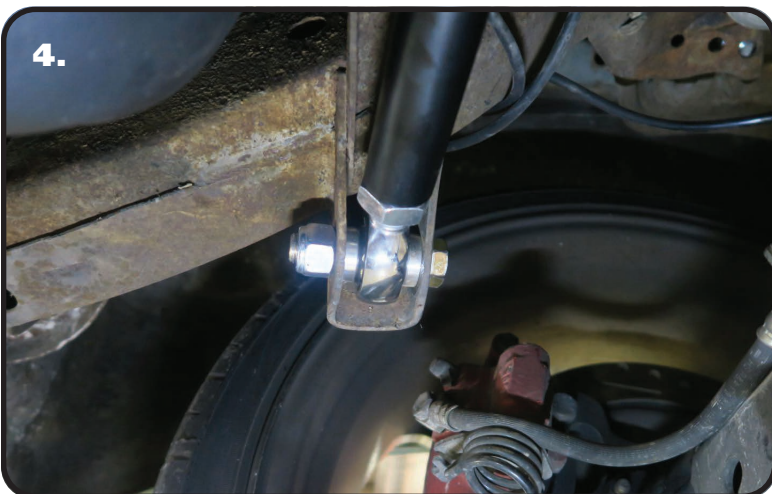

4. Insert the R-Joint Housing end of the panhard bar into the OEM frame mount. Align the align hole in the R-Joint end with the holes in the OEM mount. Install a 9/16" flat washer on a 9/16"-18 x 3" hex bolt and insert in into the aligned holes. Install a 2nd 9/16" washer followed by a 9/16"-18 nylok nut on the threads of the bolt sticking through the frame. Torque to 95 ftlbs.

5. Check the side to side dimension between the tire and quarter panel with the car at ride height. You may need to adjust the panhard bar to center the axle at ride height.



Part # 11286210 - 1965-1970 B-Body Rear CoilOvers

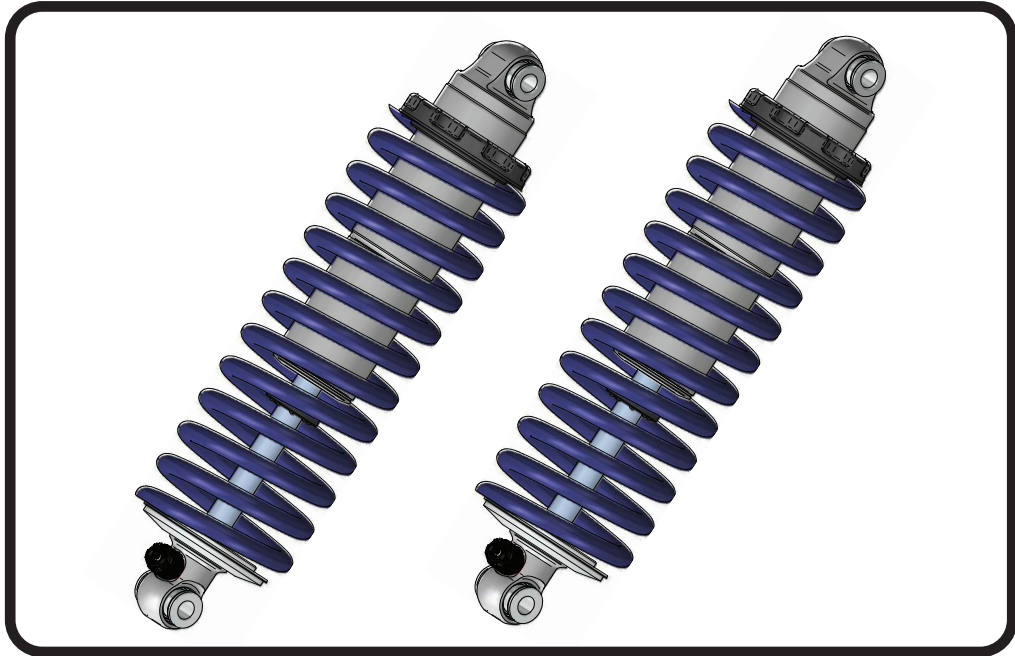

Recommended Tools

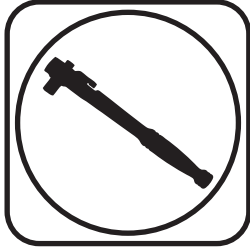

1965-1970 B-Body HQ Series Rear Coilovers Installation Instructions

Table of contents	
Page 18.....	Included components
Page 19.....	Assembly and Adjusting
Page 20.....	Final Adjusting and Preloading the Spring

CoilOver Dimensions:	
Center of bearing to Center of bearing:	
Compressed:	9.43"
Ride Height:	11.50"
Extended:	13.03"



Major ComponentsIn the box

Item #	Part #	Description	QTY
1	982-10-803	3.6" Stroke HQ Series Shock	2
2	815-05-022-KIT	1.7" Shock Eyelet	2
4	59080575	Coilspring 8" 575lb	2
5	70010828	Delrin Spring Washer	4
6	803-00-199(kit)	Lower Spring Adjuster Nut (803-00-199 kit)	2
7	803-00-199(kit)	Adjuster Nut Locking Screw (803-00-199 kit)	2
8	803-00-199(kit)	Retaining Ring (803-00-199 kit)	2
9	90002043	Shock Bearing Spacers - .605" long	4
10	90002040	Shock Bearing Spacers - .740" long	4
	90001994	5/8" ID Bearing (installed in shock and eyelet)	4
	90001995	Bearing Snap Ring (installed in shock and eyelet)	8

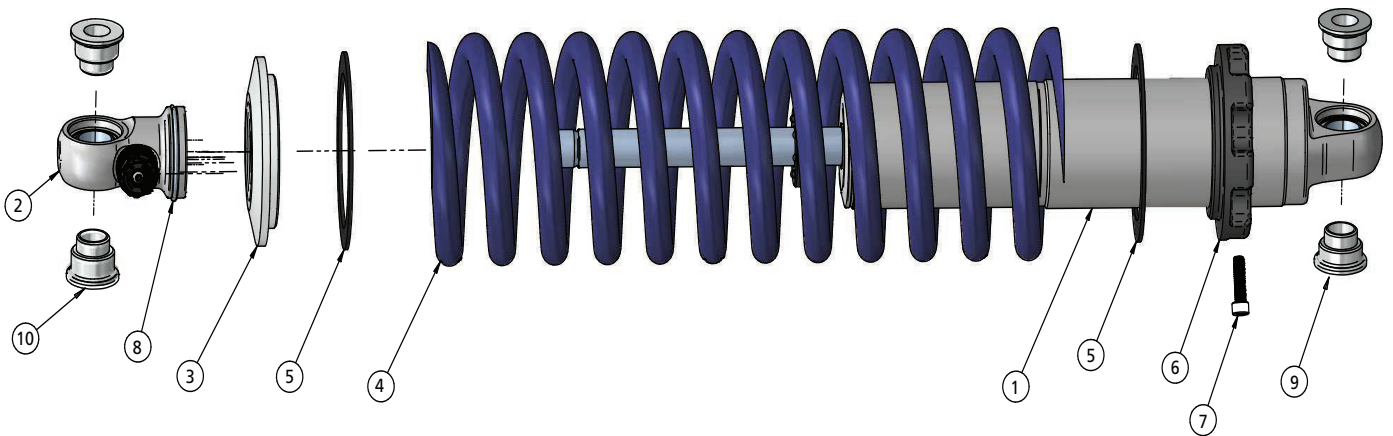

CoilOver Assembly...



1

First, using the supplied lower adjuster nut (803-00-199) thread the nut onto the shock from the bottom side as seen in figure 1. Remove the plastic pellet that is in the split of the adjuster nut.



4

Once the knob is removed slide a Delrin washer over the eyelet. Next, slide the upper spring mount (803-00-199) over eyelet as seen in figure 4.



2

Next, install a delrin washer then coil spring over the top of the shock as seen in figure 2.



5

Install upper spring mount retainer clip (803-00-199) into the groove on the upper eyelet as seen in figure 5. Then, reinstall adjuster to complete assembly.

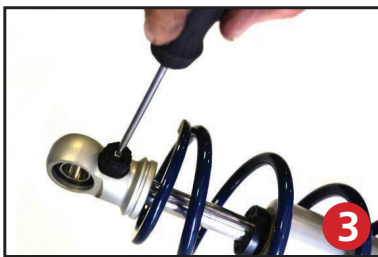

3

Before the upper spring mount can be installed screw the adjuster knob on the upper eye mount to the firmest setting (clockwise) as seen in figure 3. Then remove the Knob by holding it while removing the center screw.

Install the locking screw in the adjuster nut before setting spring preload, but DO NOT tighten until the spring preload has been set.

NOTE: Remember to adjust the shock valving before driving, the shock is currently set to full stiff.

Shock Adjustment 101- Single Adjustable

Rebound Adjustment:

How to adjust your new shocks.

The rebound adjustment knob is located on the top of the shock absorber protruding from the eyelet. You must first begin at the ZERO setting, then set the shock to a medium setting of 12.



-Begin with the shocks adjusted to the ZERO rebound position (full stiff). Do this by rotating the rebound adjuster knob clockwise until it stops.



-Now turn the rebound adjuster knob counter clock wise 12 clicks. This sets the shock at 12. (settings 21-24 are typically too soft for street use).

Take the vehicle for a test drive.



-if you are satisfied with the ride quality, do not do anything, you are set!



-if the ride quality is too soft increase the damping effect by rotating the rebound knob clock wise 3 clicks.

Take the vehicle for another test drive.



-if the vehicle is too soft increase the damping effect by rotating the rebound knob clock wise 3 additional clicks.



-If the vehicle is too stiff rotate the rebound adjustment knob counter clock wise 2 clicks and you are set!

Take the vehicle for another test drive and repeat the above steps until the ride quality is satisfactory.

Note:

One end of the vehicle will likely reach the desired setting before the other end. If this happens stop adjusting the satisfied end and keep adjusting the unsatisfied end until the overall ride quality is satisfactory.



Final Tightening and Adjusting

Ride Height

We have designed most cars to have a ride height of about 2" lower than factory. To achieve the best ride quality & handling, the shock absorber needs to be at 40-60% overall travel when the car is at ride height. This will ensure that the shock will not bottom out or top out over even the largest bumps. Measuring the shock can be difficult, especially on some front suspensions. Measuring overall wheel travel is just as effective and can be much easier. Most cars will have 4-6" of overall wheel travel. One easy way to determine where you are at in wheel travel is to take a measurement from the fender lip (center of the wheel) to the ground. Then lift the car by the frame until the wheel is just touching the ground, re-measure. This will indicate how far you are from full extension of the shock. A minimum of 1.5" of extension travel (at the wheel) is needed to ensure that the shock does not top out. If you are more than 3" from full extension of the shock then you are in danger of bottoming out the shock absorber.

Adjusting Spring Height

When assembling the CoilOver, screw the spring retainer tight up to the spring (0 preload). After entire weight of car is on the wheels, jounce the suspension and roll the car forward and backward to alleviate suspension bind.

- If the car is too high w/ 0 preload then a smaller rate spring is required. Although threading the spring retainer down would lower the car, this could allow the spring to fall out of its seat when lifting the car by the frame.
- If the car is too low w/ 0 preload, then preload can then be added by threading the spring retainer up to achieve ride height. On 2.6" - 4" stroke shocks, up to 1.5" of preload is acceptable. On 5-7" stroke shocks, up to 2.5" of preload is acceptable. If more preload is needed to achieve ride height a stiffer spring rate is required. Too much preload may lead to coil bind, causing ride quality to suffer.