

ridetech

Installation Guide & Operation Manual



airpod™
LevelPRO™
RidePRO e²®



RideTech

350 S. St. Charles St. • Jasper, IN 47546 • 812-481-4969



Contents

Thank you for choosing an Air Ride Technologies' suspension control system. We are committed to providing the best experience possible throughout the process of getting your car on air.

Our commitment doesn't end with your purchase, in fact, it has only begun. This guide should provide you with the information you need to properly install and set-up your suspension control system.

However, if you find yourself having difficulty or if you have a question that isn't covered in this book, please call our tech department.

812-481-4969

In addition to phone support, our web site also provides a wealth of helpful product / install / set-up information.



AirPod™ Installation

- Mounting the unit4
- Wiring.....4

Component Installation

- Mounting compressor & relay.....5
- Mounting tank5
- Mounting air valves6
- Routing air lines & fittings6
- Mounting pressure sensors.....6
- Mounting the controls & ECU.....7
- Wiring.....7

LevelPRO Installation

- Mounting ride height sensors.....8
- Sensor Rod Assembly.....9
- Example installations 10
- Calibrating Ride Height Sensors..... 11

Programming & Controls

- Programming and activating presets..... 12
- Ride Height on start..... 13
- Display view options 13
- Programming remotes..... 13
- View Tank Pressure 14
- Operating pressures & triggers
 - Compressor trigger..... 14
 - Inflate / deflate speed..... 14
 - Full deflate feature 14
- Adjusting display & backlight intensity 15

Wiring Diagrams

- ARC4000L / ARC4000e2 16
- ARC4100L / ARC4100e2 17
- ARC4700L / ARC4700e2 18
- ARC4800L / ARC4800e2 19

Problem Solving 20

Systems covered in this manual:

This guide covers installation of all RidePRO e2®, LevelPRO™ and AirPod™ systems. It is important to know what system you are installing and what sections pertain to your application. Check below to ensure you understand your system's configuration.

LevelPRO™ and RidePRO e2® Systems differ only in the addition of the ride height sensors. These sensors add the ability to adjust the height of the vehicle based on actual chassis movement as well as air spring pressure readings. RidePRO e2 Systems can be upgraded to a LevelPRO™ with the purchase of the additional sensors (LEV7500).

LevelPRO™

Part #	
ARC4000L	LevelPro 4 way system / 3 gal. Tank
ARC4100L	LevelPro 4 way w/dual comp. / 5 gal. Tank
ARC4700L	LevelPro BIG RED 4 way / 5 gal. Tank
ARC4800L	LevelPro BIG RED MAX / two 5 gal. Tanks
LEV7000	LevelPro electronics package
LEV7500	LevelPro upgrade for RidePro E2

Ride height sensors are used in LevelPRO™ systems only.



RidePRO e2®

Part #	
ARC4000e2	RidePro e2 4 way system / 3 gal. Tank
ARC4100e2	RidePro e2 4 way /dual comp. / 5 gal. Tank
ARC4700e2	RidePro e2 BIG RED 4 way / 5 gal. Tank
ARC4800e2	RidePro e2 BIG RED / two 5 gal. Tanks

RidePROe2® systems use pressure sensors only

The AirPod™ is a complete RidePRO e2 or LevelPRO™ System in a pre-assembled and tested unit for simple installation.



airpod™

Part #	
APOD4100L	AirPod w/ 5 gal. Tank, 2 compressors, and LevelPro control
APOD4000L	AirPod w/3 gal. Tank, single compressor and LevelPro control
APOD4100e2	AirPod w/ 5 gal. Tank, 2 compressors, and Ridepro control
APOD4000e2	AirPod w/3 gal. Tank, single compressor and RidePro control

AirPod™ electronics & controls are identical to LevelPRO™ and RidePRO e2® systems.

Upgrade Options

LevelPRO™

All RidePROe2 systems can be upgraded with the LevelPRO™ ride height sensors for the ultimate suspension control.

Part #	
LEV7500	LevelPro electronics package



Remote Control

Add the convenience of remote control to your Air Ride Technologies suspension system with this optional upgrade.

Part #	
REM7500	Remote control option





Remove the negative battery cable before beginning installation.



MOUNT THE MAIN UNIT:

- 1 - Mount airpod in the trunk or other area where the airpod will not be exposed to the elements (ECU is NOT water proof!)
- 2 - Mount the base flat to the vehicle surface (do not bend the base)
- 3 - Secure the base with self tapping screws or bolts.
- 4 - Secure the cover to the airpod base using the supplied screws.



CONNECT AIR LINES:

- 1 - Airline cuts must be straight and clean - use a razor blade or tubing cutter. (part # - cut1000)
- 2 - All fittings are DOT approved, reusable, push-to-connect style. Firmly push the airline into the fitting to attach. To release the airline pull the collar on the fitting back towards the fitting and pull the airline out.
- 3 - All of our airlines are DOT approved so they are very strong. Secure the airline with zip ties, keep them away from any sharp edges and when passing through a hole in the frame use a grommet.
- 4 - Keep away from intense heat including mufflers and exhaust manifolds.

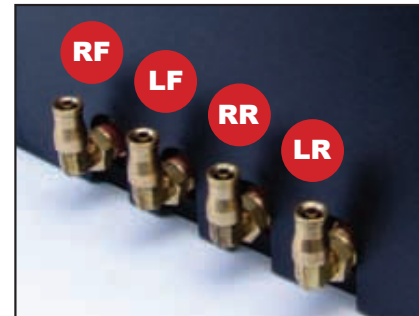

CONNECT POWER HARNESS:

- 1 - Connect the red power wire directly to the battery. Use included fuse within 18" of battery.
- 2 - Connect the yellow ignition wire to switched 12v.
- 3 - Connect the black wire to chassis ground.

Be sure to use included fuse holder in the battery feed wire as close to the battery as possible.

CAUTION: Use 10 gauge wire or larger to extend red power feed if needed

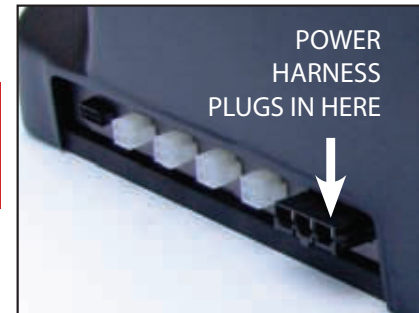
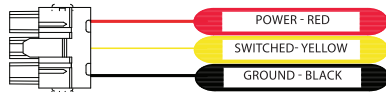

CONNECT LEVELPRO SENSORS (if equipped):

(if equipped):

See LevelPRO section for more information on installing and calibrating height sensors. (see page 8)

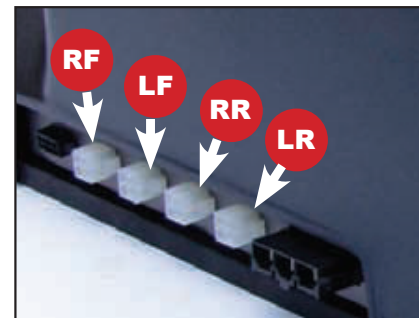

CONNECT DISPLAY / CONTROLS:

See control programming and additional features section for more information on using the control panel.

(see page 11-15)





Component Installation Instructions

LevelPRO & RidePRO e2

LevelPRO Part #: ARC4000L ARC4100L ARC4700L ARC4800L
 RidePRO e2 Part #: ARC4000e2 ARC4100e2 ARC4700e2 ARC4800e2

Remove the negative battery cable before beginning installation. STOP

Mounting the Compressor & Relay

- All of our compressors are sealed for moisture and dust resistance so they can be mounted anywhere on the vehicle. Although it is best to mount it in a place out of direct contact with rain and snow. It is OK to mount it underneath the vehicle but keep it inside the frame rails away from water and debris thrown off the tire.
- This is a dry compressor; therefore it is maintenance free and can be mounted in any position.
- It is best if mounted to something solid to reduce vibration and noise. If mounting it to sheet metal or the bed of a truck use sound deadening material between the compressor and the mounting surface.
- Use the rubber grommets supplied on the feet of the compressor to reduce vibration.
- A main power wire of 12AWG. or larger will be needed to supply each compressor. It will attach to the Red wire on the relay. The yellow wire on the relay will go to the Red wire on the compressor. The black wire on the compressor should be attached to a clean ground, usually the frame. The small gray and orange wires will plug into the RL1 port on the ECU.
- If you are running two compressors you will need an additional relay that will plug into the RL2 port. (Part # - WIR8500)
- Thomas Compressors (black) will require a 20 amp fuse (each).
- Viair Compressor (silver) will require a 30 amp fuse (each).

Use spacer for better cooling

Filter / muffler install on inlet

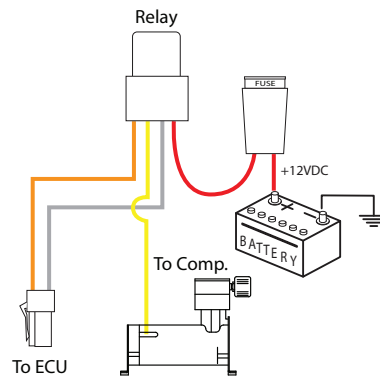
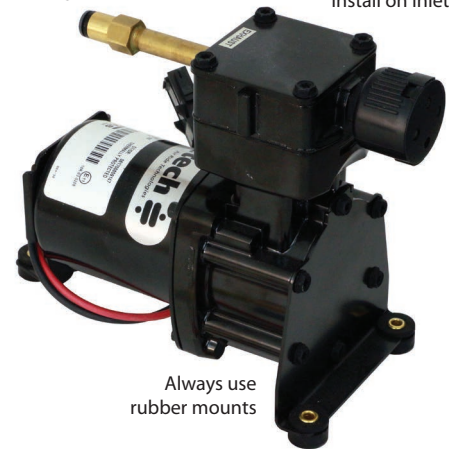

Mounting the Air Tank

- The air tank can be mounted anywhere on the vehicle in any position. (sensor cannot be on bottom)
- There is an 1/8" port in the tank that will accept the tank pressure sensor.



Component Installation Instructions



LevelPRO Part #: ARC4000L ARC4100L ARC4700L ARC4800L
RidePRO e2 Part #: ARC4000e2 ARC4100e2 ARC4700e2 ARC4800e2

Mounting the RidePro Air Valves

- The valves, like the compressor, are sealed and can be mounted in the same locations. Although if the vehicle will be exposed to freezing temperatures it is a good idea to mount them in the engine bay if possible to reduce the possibility of freezing.
- They can be mounted in any position.
- Attach the ground strap to a good, clean ground (preferably the frame).
- The exhaust port will be left open.
- The valve is held closed with the pressure in the tank. If tank pressure drops below air spring pressure they will equalize, deflating all 4 air springs.

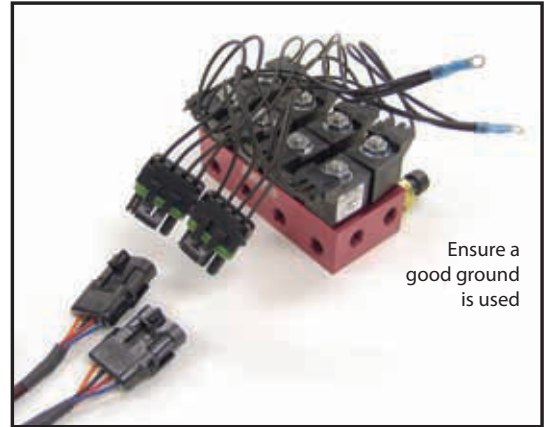

Routing the Airline and Fittings

- Make all airline cuts with a razor or tubing cutter (part # - cut1000). It must be clean and straight or it will not seal.
- All fittings are DOT approved push-to-connect style. They are very simple to use and are reusable. Firmly push the airline into the fitting to attach. To release the airline pull the collar on the fitting back towards the fitting and pull the airline out.

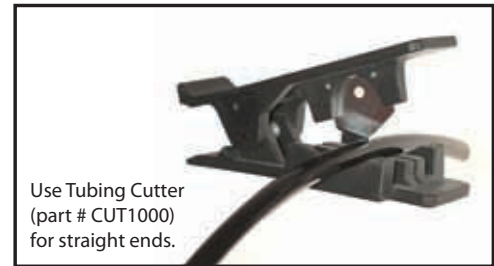

Use thread sealant on all fittings.

- Do not over tighten the fittings. This could result in breaking the fitting or damaging the air spring.
- All of our airlines are DOT approved so they are very strong. But keep them away from any sharp edges. Also when passing through a hole in the frame use a grommet.
- Keep away from intense heat including mufflers and exhaust manifolds.
- Use zip ties or other fasteners to secure the airline.

Mounting the Air Pressure Sensors

- These sensors are voltage based and do not need to be grounded.

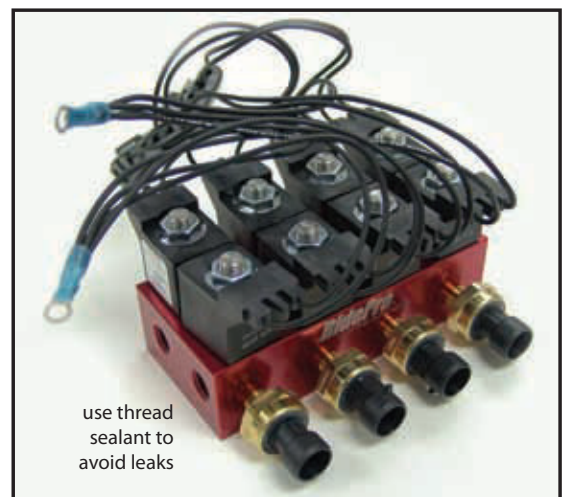

Component Installation Instructions

LevelPRO Part #: ARC4000L ARC4100L ARC4700L ARC4800L
 RidePRO e2 Part #: ARC4000e2 ARC4100e2 ARC4700e2 ARC4800e2



Mounting the ECU (Electronic Control Unit) & Control Panel

- The control panel should be accessible from the drivers seat and may be surface mounted, flush mounted, or left unmounted. A larger faceplate is included to allow proper flush mounting of the control panel.
- 6ft. extension cables for the control panel harness are available if needed.



ECU is NOT water proof!



ECU Wiring Connections

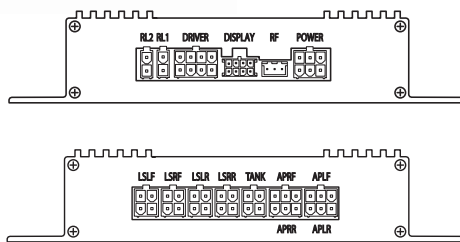

Main Power Harness

Black wire

A clean chassis ground

Yellow wire

Ignition
(12 volts only when the key is on)

Red wire

Constant 12 volt

Green wire

Illumination
(12 volts only when lights are on, this will dim the gauges-
Not required but is suggested)



Height Sensor Harness



There are 4 separate harnesses for the height sensors. They are labeled per corner and the ECU is marked; LSLF (Level Sensor Left Front) Etc.

Air Pressure Sensor Harness



This harness has 3 plugs; one 4 pin plug for the Tank pressure and two 6 pin plugs for the air spring pressures.

The tank pressure harness will connect to the plug on the ECU labeled "tank". The supplied air spring pressure connectors are labeled on the ECU as APRF (Air Pressure Right Front) & APLF. The plug with the Blue wire will connect to the APRF and the plug with the green wire will connect to the APLF. The other end is labeled accordingly.

Air Valve Harness

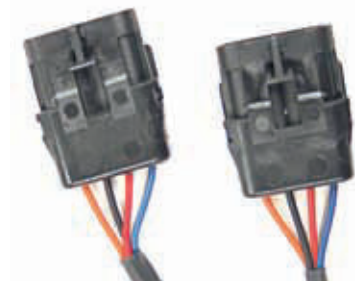

This harness has 8 pins and will plug into the connector labeled "Driver". The other end has two black Weather Pack connectors that will plug directly into the RidePro air valves. These plugs are labeled for "Front" and "Rear". If you have the Big Red valves an adapter harness is needed.

LevelPRO™

Ride Height Sensors (RidePro E2 systems will not use height sensors)

- The LevelPro system uses 4 height sensors (one at each wheel). They are weather proof and may be mounted in any position as well as “clocked” in any position. (There is not a difference between the left and right sensors.) These sensors are typically mounted to the chassis / frame rail.
- A linkage with rubber ends connects the sensor arm and a suspension component. On most front suspensions the linkage will attach to the upper or lower control arm. On most rear suspensions it will attach to the axle or control arm.
- **The main goal when mounting the sensor is to achieve as much sensor rotation as possible without exceeding the sensors limits.**
- Although the sensor arm will rotate 180 degrees, it must remain in the middle 90 degrees throughout suspension travel. See diagram below for sensor travel limits.
- It may be necessary to shorten the sensor arm and drill a new hole to ensure the arm is rotating enough during suspension travel to accurately determine vehicle height.
- The sensor arm can also be removed from the sensor and clocked in four different positions. It may also be necessary to bend the sensor arm and/or linkage to achieve proper clearance and alignment.
- The sensor will be mounted to the frame using ¼” self tapping screws or bolts. A special shouldered bolt is supplied to attach the rubber rod ends to the suspension and the sensor arm, this will avoid over tightening.
- Make sure the sensor has adequate clearance from all suspension components throughout suspension travel. Check tire clearance, lock to lock and throughout suspension travel.

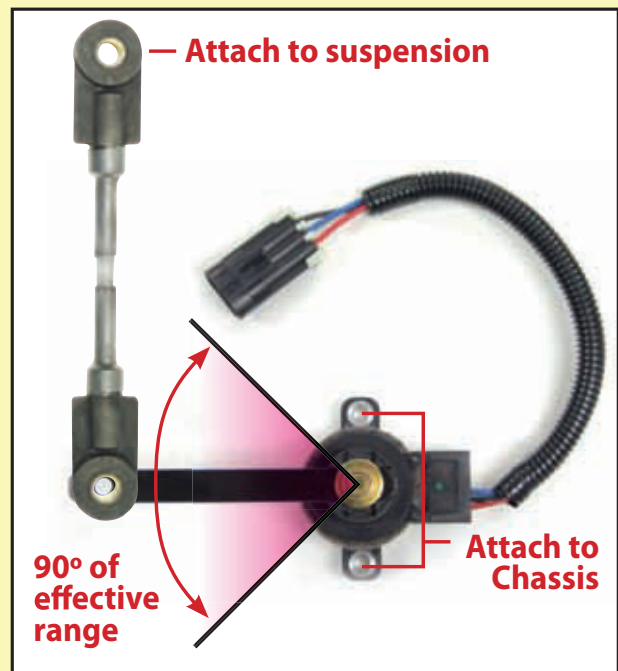

Travel Limits

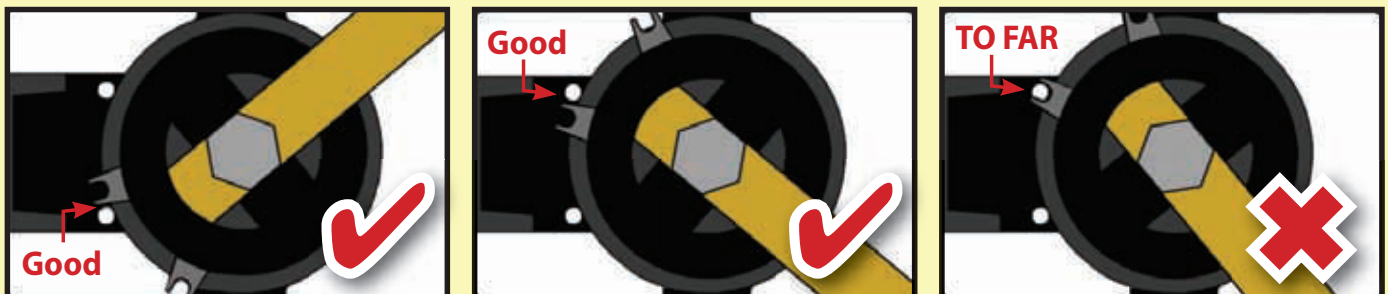

- ⚠ If the electrical range of travel is exceeded the system may function erratically or not at all.
- ⚠ Also note that if the sensor has very little travel the LevelPro system may not perform to its potential.
- ⚠ It may be necessary to shorten the sensor arm to increase travel.

Assembly of the LevelPRO Sensor Link Rods



1- Once the linkage rod has been cut to the proper length assemble the linkage rod with heat shrink tubing and the rubber end.



2- Slide the heat shrink tubing over the rubber end as far as it will go.



3- Heat the shrink tubing with a heat gun (hair dryer or small torch will work). **Begin by heating the rubber end first.** The heat shrink is lined with adhesive and will stick to the rubber when heat is applied.



4- Continue shrinking the tube to the rod until secured. Be sure not to overheat the tubing causing it to pull from the rubber end.



5- Once both sides of the linkage have been finished secure the linkage to the sensor and suspension.



69 Camaro Front



Rear Trailing Arm



58-64 Impala Front

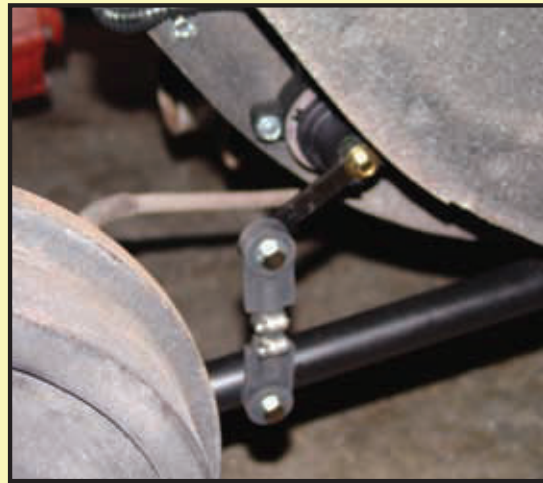

65-70 Mustang Rear



Triangulated 4-Link Rear



C-10 Truck Rear

LevelPro™ Ride Height Sensor Initial Calibrating Procedures

For systems with height sensors ONLY -

If you do not have LevelPro™ height sensors, skip to page 12 to program the presets.

(If you are not using ride height sensors, you do not need to calibrate the ECU.)

Upon initial installation the ECU needs to be calibrated to learn the specific characteristics of the ride height sensors being used. This short initial programming sequence avoids the requirement for “position specific” sensors.

This calibration will only teach the main ECU the minimum / maximum values of the level sensors. It will not program the presets.

The goal is to “teach” the ECU the highest position AND the correct direction of travel of the ride height sensors.

Calibrating height sensors for fully raised & lowered positions:

- 1 Start by raising the vehicle to ride height. (About ½ way up.)
Wait for compressor to turn off.

⚠ The following steps are time sensitive.

- 2 Press and hold the Air Ride Logo Programming Button for 3 seconds. (Fig.1) This will illuminate the programming button and will activate the programming sequence.
- 3 Manually raise the suspension to full extension. This can be accomplished via the manual inflate buttons on the control panel.

⚠ NOTE: The ECU must sense an upward movement after pressing the Logo button and reach full height within 10 seconds.

- 4 Press preset # 3 and release (do not hold). (Fig.2) This will illuminate the #3 button and the ALL height indicator bars.
- 5 **Immediately after the step above**, lower the vehicle to its lowest height.
- 6 Press preset # 1 and release (do not hold). This will illuminate the #1 preset button and one height indicator bar at each corner. (Fig.3)
- 7 Wait 10 seconds for the logo button light to turn off.
- 8 Raise and lower the vehicle to ensure each bar graph moves as it should.



Fig.1

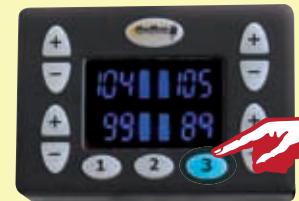

Fig.2



Fig.3

Programming & Features

Programming the Presets

Preset #1- This is normally set as the Lowest Height.

⚠ Do not program it for 0 psi. Set this preset for the highest pressure that allows the suspension to be fully compressed. This will decrease the air pressure / time needed to raise the vehicle to ride height.



- 1 - Set the vehicle to the desired height using the manual inflate/deflate buttons.
- 2 - Press and hold Preset Button #1 for 6 seconds. (Just like setting a radio station in your car).
The #1 button will light after 3 seconds, then will begin flashing after 6 seconds to indicate successful programming. Flashing will cease once the button is released.

Preset #2- This is normally set as Ride Height.

The ride height of the vehicle should be about mid travel. Refer to the air spring installation instructions to determine the exact ride height specifications of your suspension.



- 1 - Set the vehicle to the desired height using the manual inflate/deflate buttons.
- 2 - Press and hold Preset Button #2 for 6 seconds. (Just like setting a radio station in your car).
The #2 button will light after 3 seconds, then will begin flashing after 6 seconds to indicate successful programming. Flashing will cease once the button is released.

Preset #3- This is normally set at the fully Extended Height.

⚠ Driving with the suspension fully extended may damage the system. Air suspensions are not designed to be driven all the way up, this is only for clearing steep driveways, speed bumps, loading the car on the trailer, etc.



- 1 - Set the vehicle to the desired height using the manual inflate/deflate buttons.
- 2 - Press and hold Preset Button #3 for 6 seconds. (Just like setting a radio station in your car).
The #3 button will light after 3 seconds, then will begin flashing after 6 seconds to indicate successful programming. Flashing will cease once the button is released.

Activating the Presets

After programming the presets they can be activated by pressing either 1,2 or 3 for three seconds. **Be careful not to hold it too long. If you hold it for 6 seconds it will reprogram that preset.**

Programming & Features

Additional Settings & Features

“Ride Height on Start” Feature - Enable or Disable:

This feature will inflate the vehicle to Preset #2 any time the ignition is turned ON. With the “Ride Height on Start” feature activated the Air Ride Logo button and the manual inflate/deflate buttons will ALL be illuminated. Simply press the Air Ride Logo programming button to activate or deactivate this feature.

“Ride Height on Start” feature - ON:



“Ride Height on Start” feature - OFF:



Display View Options:

Press and hold the Air Ride Logo Button for 3 seconds until the Air Ride Logo Button is illuminated.



Press preset button #1, 2, or 3 to change display settings.

1. Numeric (air pressure)



2. Bar graph (level sensor)



3. Numeric with bar graph [both].



Normal operation will resume after 10 seconds or by pressing the Air Ride button.

Programming Remotes:

If you have the optional key fob remote controls, you will be able to activate the 3 presets from outside the vehicle. The remotes will only work with the ignition in the OFF position. To activate the remotes they must first be programmed to communicate with that specific ECU. Up to 3 remotes can be programmed.

1 - With ignition on, press the Air Ride Logo Button 3 times, the Logo button will illuminate. (remotes only work with ignition off)



The systems can use up to 3 remotes - 2 are included in the remote kit.



2 - Press button #1 on the first remote, the Logo button will flash off momentarily.



3 - After the logo button lights again, press button #1 on the second remote, the Logo button will flash off momentarily.



4 - After the logo button lights again, press button #1 on the third remote, the Logo button will flash off momentarily.

Normal operation will resume after 10 seconds or by pressing the Air Ride button.

Programming & Features

Viewing Tank Pressure:

To view the air tank pressure press and hold the Air Ride Logo Button and #2 simultaneously for 3 seconds. The tank pressure will be displayed in the Left Front corner.

Press the logo button to return to the main screen.



Adjusting system operating pressures and triggers:



To enter sub-programming menu for the 3 program settings below, start by viewing tank pressure (hold down Air Ride Logo button and #2 simultaneously for 3 seconds) then enter sub-programming menu by holding down #1 and #3 simultaneously

Adjusting Compressor Trigger:

Enter sub-programming menu as shown above.

You can change the pressure at which the compressor(s) turn on - anywhere from 135-150psi. This allows you to decide whether your compressor(s) should run less often for a longer amount of time, or if they should run more often for a shorter amount of time. If set too close to 150psi the compressors may toggle on/off rapidly.

NOTE: When using two compressors the secondary pump will activate 3 seconds after the first pump to lower inrush current draw on your electrical system.



Use the right front inflate/deflate (+/-) buttons to adjust the pressure trigger.

Altering the Inflate and Deflate Preset Speed of the system:

Enter sub-programming menu as shown above.

You may increase or decrease the number of pulses required to achieve a preset. There are five levels with level 1 being the slowest, but most accurate, and level 5 being the fastest.

Use the left front inflate/deflate (+/-) buttons to adjust the inflate / deflate speed.

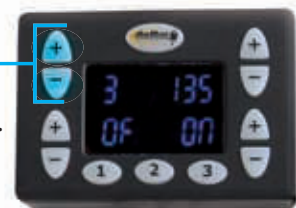

Full Deflate Feature:

Enter sub-programming menu as shown above.

When enabled this feature will allow the #1 preset to go to full deflate in one shot instead a deflating in stages. This will allow for a quicker deflate.



Use the right rear inflate (+) button to turn the feature on & the deflate (-) button to turn the feature off.

Programming & Features

Adjusting light intensity:



To activate programming sequence for the 2 display settings below, start by holding down Air Ride Logo button for 3 seconds then hold down #1 and #3 simultaneously. The display will not change.

Display Intensity:

Activate programming sequence above.

This will alter the brightness of the VFD display. This can also be dimmed by applying 12 volts to the green wire in the main power harness.



Use the right front inflate/deflate (+/-) buttons to adjust the display intensity.

Button Backlight Intensity:

Activate programming sequence above.

This will alter the brightness of the LED backlights for the buttons.

Use the left front inflate/deflate (+/-) buttons to adjust the backlight intensity.

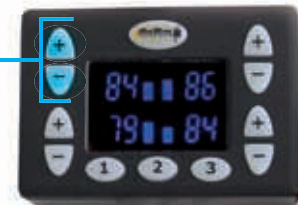

ARC4000L ARC4000e2

(shown with LevelPro™
Optional Ride Height Sensors)

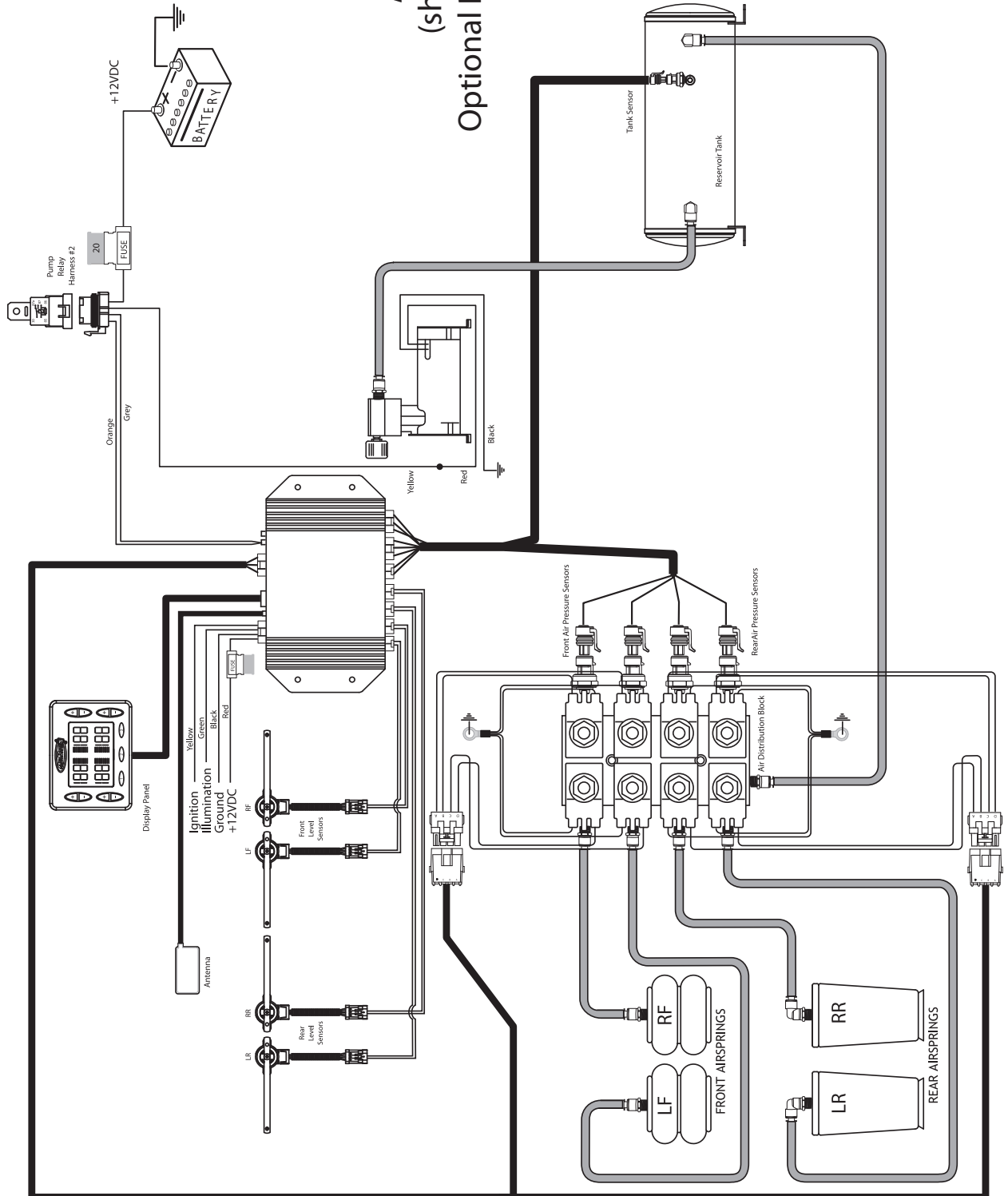

ARC4100L ARC4100e2

(shown with LevelPro™
Optional Ride Height Sensors)

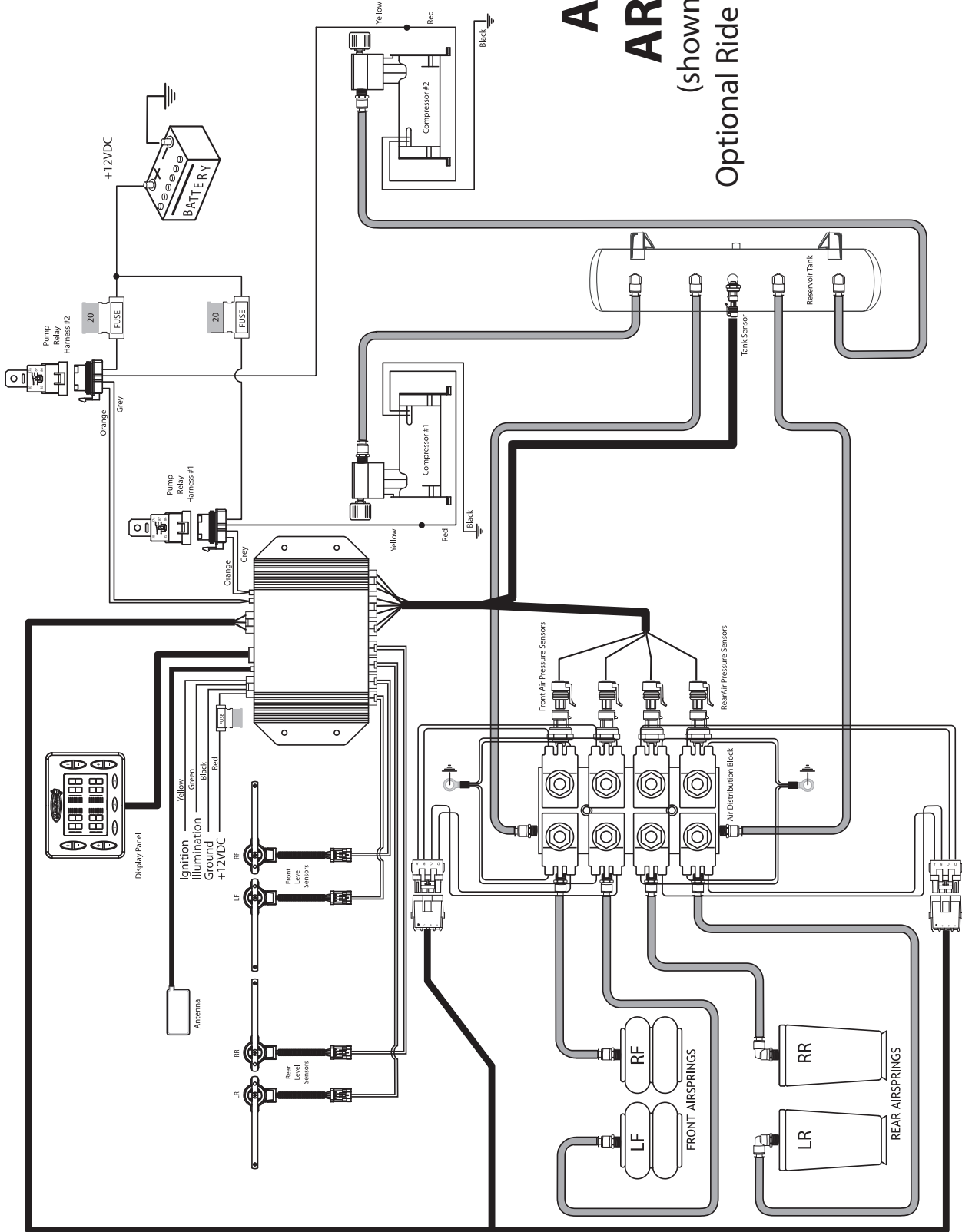

ARC4700L

ARC4700e2

(shown with LevelPro™
Optional Ride Height Sensors)

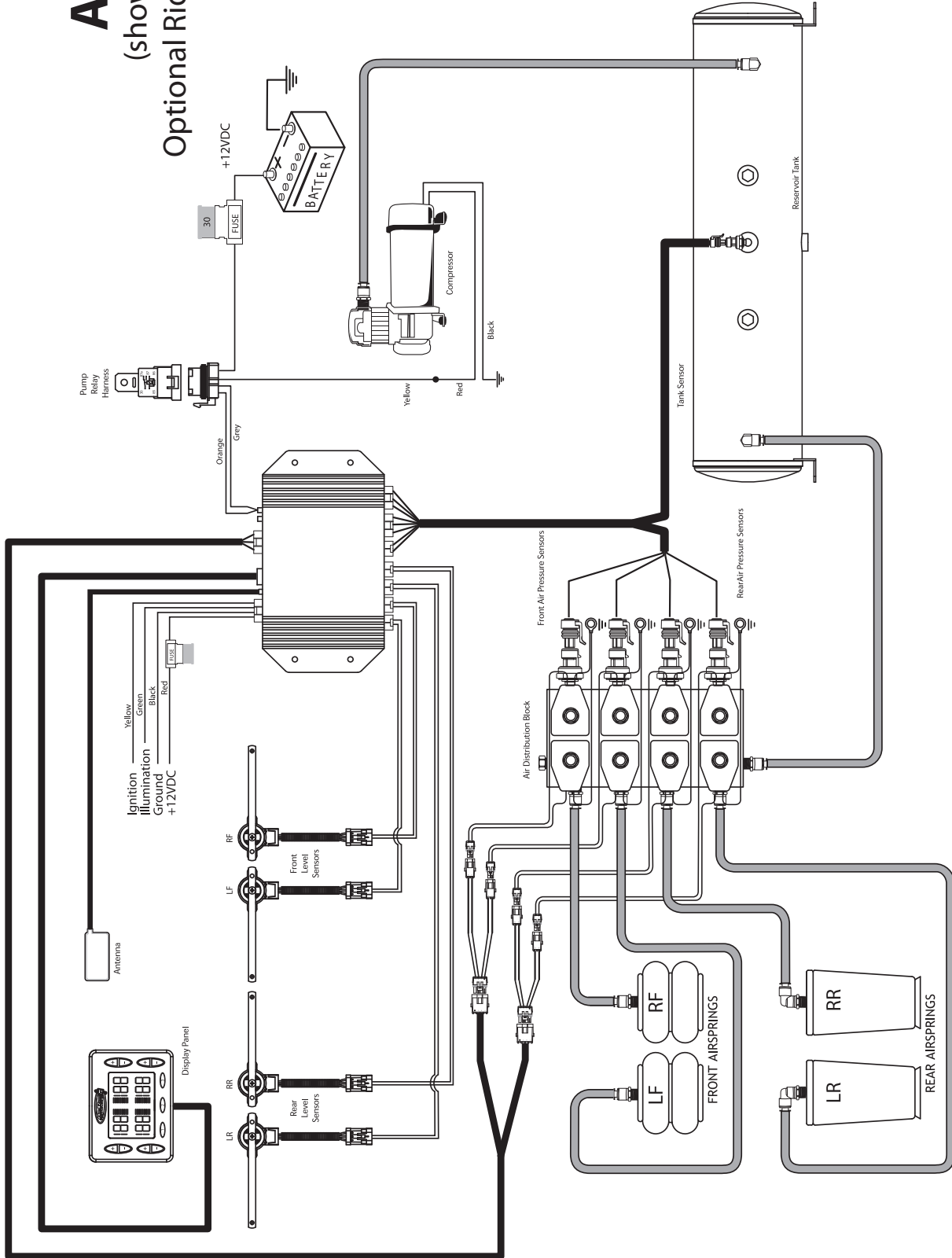

ARC4800L ARC4800e2

(shown with LevelPro™
Optional Ride Height Sensors)

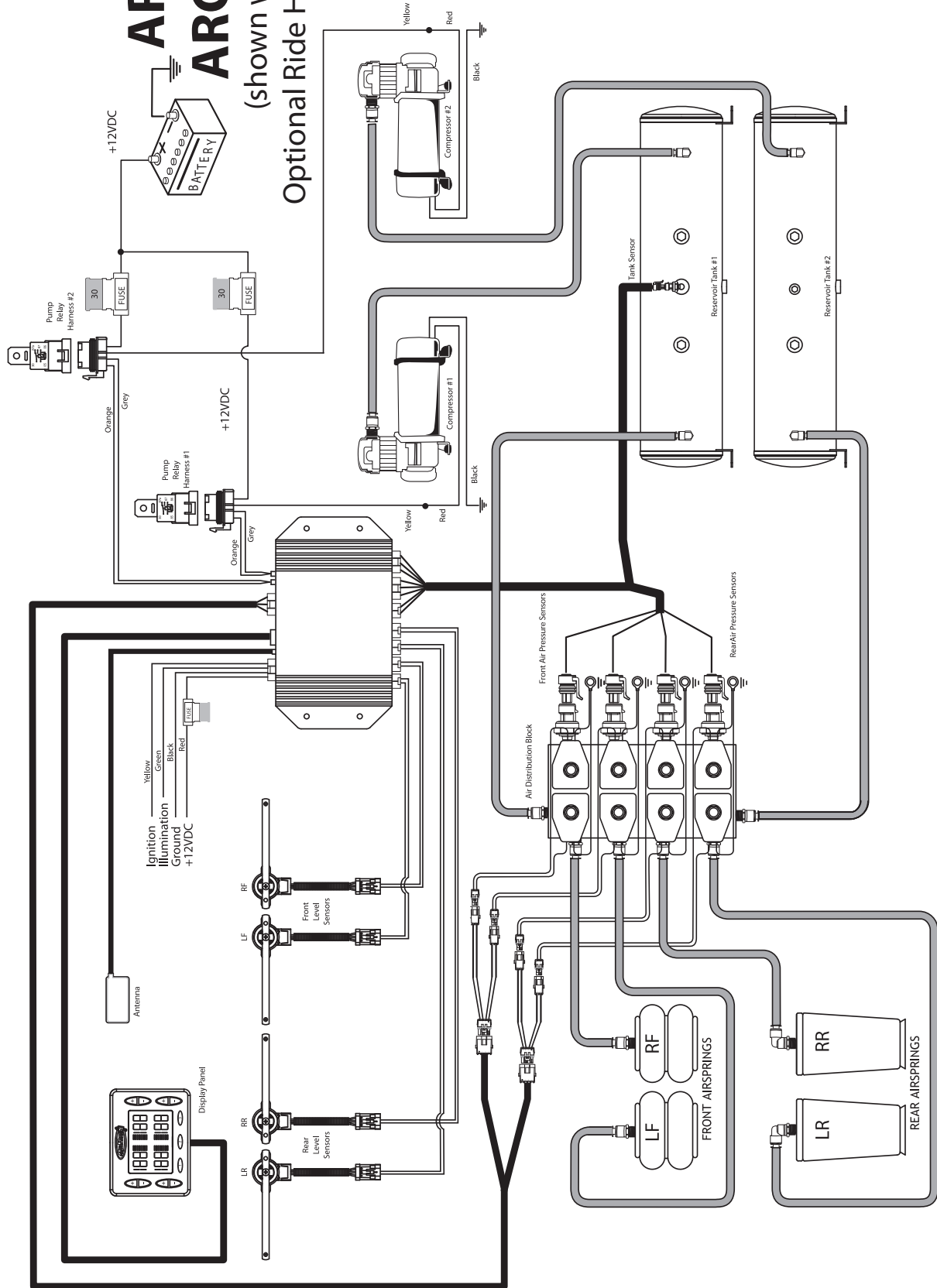

Problem / Symptom: **Possible Causes:** **Solutions:**

<p>Ride Height on Start feature does not work.</p>	<p>1. Low pressure override is activated and tank pressure is too low.</p>	<p>1. Turn Low Pressure Override to the OFF position in ECU programming.</p>
<p>Compressor toggles on & off. The compressor continuously turns on and off.</p>	<p>1. Tank pressure trigger is set too high.</p>	<p>1. Set tank pressure trigger to 135. (see page 11)</p>
<p>Vehicle does not reach presets. Vehicle will raise but misses the preset. Vehicle raises but never reaches the preset. Vehicle takes a long time to reach preset (or never reaches preset). Vehicle raises above the preset, then fully deflates.</p>	<p>1. If one side raises, and one side does not, the pressure sensors may be plugged-in incorrectly. 2. The system times out before the preset can be reached. This could be caused by two problems, 1-large heavy vehicle with small bags, or 2-not enough air supply to reach preset destination. 3. Speed of system is too slow. 4. Speed of system is too fast. 5. Vehicle raises and lowers, but the air pressure reading never changes. 6. In some vehicles the air pressure only based systems are not accurate enough to attain the desired ride height.</p>	<p>1. Check the air pressure sensor harness to ensure all connections are correct. 2. Increase the speed of the system. (see page 9) 3. Increase the air storage capacity of the system. 4. Reduce system speed as required. (see page 9) 5. Possible air pressure sensor failure. Swap two pressure sensor and see if the problem follows the sensor. 6. Upgrade to the Level Pro system, which utilizes level sensors.</p>
<p>Vehicle does not reach presets. (LevelPro only) Height bars fluctuate. Vehicle will raise but misses the preset.</p>	<p>1. Height sensor is out of range. 2. If one side raises, and one side does not, the level sensors may be plugged-in incorrectly.</p>	<p>1. Remount sensor or change linkage. (see page 6) 2. Check the level sensor harness to ensure all connections are correct. 3. Re-Learn level sensors</p>
<p>Inaccurate air pressure reading. Air pressure reads incorrectly on one corner.</p>	<p>1. Air Pressure sensors may not be plugged-in correctly. 2. Faulty air pressure sensor. Normally caused by excessive water in the compressed air system.</p>	<p>1. Check the air pressure sensor harness to ensure all connections are correct. 2. Replace sensor. If you remove the sensor and it is saturated with water, you should position the sensors above the tank.</p>

Problem / Symptom: **Possible Causes:** **Solutions:**

<p>Compressor will not turn on. Red wire at compressor shows 12 volts, but compressor does not run.</p>	<p>1. Poor compressor ground. 2. Faulty connection between battery and compressor. 3. Bad compressor.</p>	<p>1. Make sure there is a clean connection directly to the frame. 2. Even though there is 12v at the compressor, there may not be sufficient amperage. Have battery checked. 3. Replace the compressor.</p>
<p>Compressor will not turn on. (May not shut off in some cases) No power to red wire at compressor. Gauge shows above 135 psi. in the tank.</p>	<p>1. Blown compressor fuse or relay fuse. 2. Low voltage, bad connection, faulty relay. 3. ECU improperly programmed. 4. Tank sensor failure</p>	<p>1. Replace fuse. 2. Check voltage. Check Connections. Replace relay. 3. Change the ECU program to turn the compressor on at 135 psi. 4. Check tank pressure</p>
<p>Vehicle does not stay at height when parked. One air spring leaks down over a period of time. When one air spring leaks down, the leak can be located between the air distribution valve and the air spring. Use soapy water in a spray bottle to help find leaks. You can also switch the delivery lines at the valve to determine whether the leak is at the valve or at the air spring.</p>	<p>1. Leak between the fitting and the air spring. 2. Leak between airlines and fitting. 3. Exhaust valve is leaking. Normally due to debris stuck on the valve seat. 4. Air spring is leaking. (Check the fittings first, it is almost always the cause of the problem)</p>	<p>1. Tighten fitting or reseal with more thread sealant. Replace fitting if required. 2. Remove airline, cut end straight and flush, properly repeat airline. 3. Cycle that valve up and down numerous times to dislodge the debris. Or use shop air to blow out the valve. 4. Replace air spring.</p>
<p>Vehicle does not stay at height when parked. All 4 air springs leak down over a period of time. There is a leak in the supply side of the system. This could be at the compressor, tank, or supply ports on the valve. Usually the air springs with more pressure will start to drop first.</p>	<p>1. Leak between compressor and tank. 2. Leak between tank and supply port on air distribution valves.</p>	<p>1. Tighten fitting or reseal with more thread sealant. Replace fitting if required. 2. Either tighten the fitting, use more thread sealant, replace the fitting, or cut and repeat the airline as described above.</p>

Air Pressure only based systems are only as accurate as the pressure of the sensor. As the pressure in each airspring may not be exactly the same each time the vehicle is raised to the same ride height, it is impossible to make the system extremely precise based only on air pressure. Air pressure only based system should expect to reach within 1/2-inch of ride height. Air pressure and level sensor based systems should expect within 1/8-inch repeatability.