



**INSTALLATION
INSTRUCTIONS**



Part # 20479844



6.65" Stroke Rear RQ-S Shock

Wide T-Bar/Eye



www.ridetech.com
812.482.2932





**Please Read And Understand All Instructions
And Warnings Prior To The Installation Of
This Product.**



THANK YOU

Congratulations on your new ridetech product! It's an honor that you've selected the ridetech brand to upgrade your ride. Our products are developed around quality and performance without compromise. We're confident you'll have many years (and miles) of pure driving enjoyment.
Thank you for choosing ridetech!

Road Map

Exploded View & Parts Listing	3
Shock Installation	4
Shock Tuning Guide	5-6

Shock Dimensions	
Measured From Center Eye To Center Eye	
Compressed	12.15"
Ride Height	16.00"
Extended	18.80"



EXPLODED VIEW AND PARTS LISTING

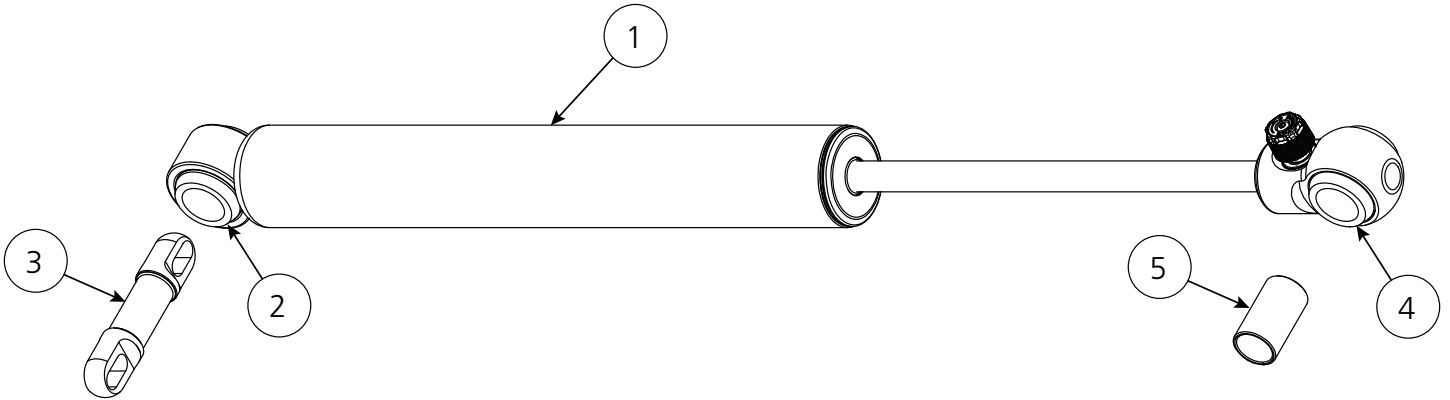
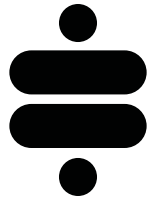

Item #	Part #	Description	Qty
1	20479999	6.65" Stroke Shock - Steel Body	1
2	70011139	5/8" ID Shock Bushing	1
3	90002068	Wide Trunnion	1
4	70011138	3/4" ID Shock Bushing	1
5	90002103	Sleeve, 3/4" OD	1

Shock Installation

1. Attach the trunnion in the OEM Location using the OEM Hardware (Figure 1).

It may be necessary to rotate the trunnion to install the hardware. This can be done by sticking a screwdriver in one of the slots and spinning the trunnion in the shock bushing.

2. Press the 3/4" OD sleeve into the shock eyelet.

3. Attach the EYELET of the Shock in the OEM mount that is on the axle housing or control arm.

Attach the shock using the OEM hardware. Position the shock with the adjuster knob pointing out, away from the axle (Figure 2).

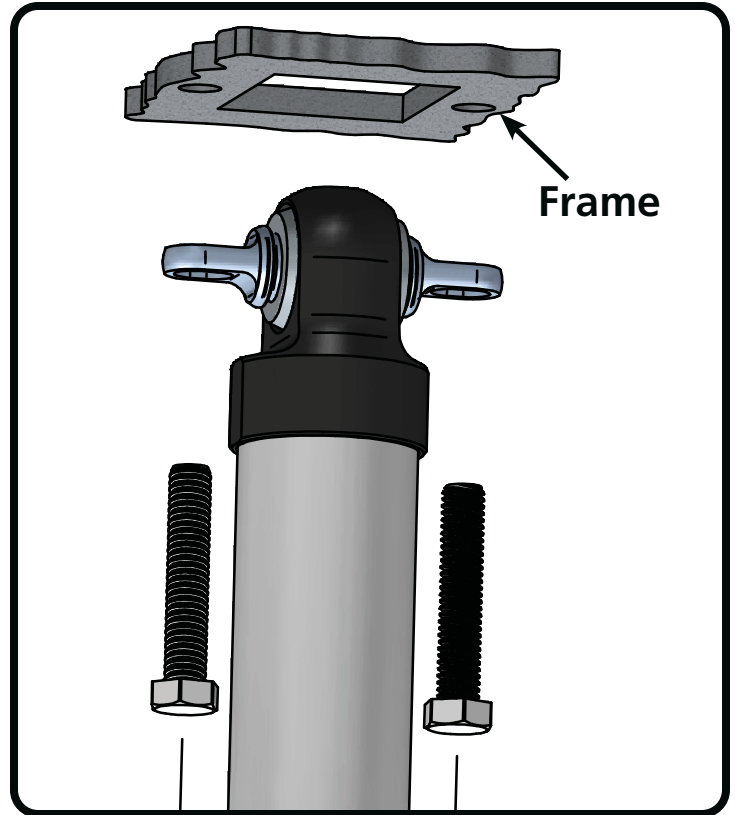

Figure 1



Figure 2



TUNING GUIDE

SINGLE-ADJUSTABLE SHOCKS



The Basics...



COMPRESSION

This typically occurs when you hit a bump in the road. The bump forces the wheel/tire/suspension assembly to "compress" or move upwards into the car.



REBOUND

Rebound is the opposite of compression. This occurs when the wheel/tire/suspension assembly falls into a pothole, or simply "rebounds" from being compressed.

Where Are The Knobs?

RQ-S Series Shocks

- The adjustment knob is located on the top of the shock, either protruding from the side of the eyelet, or atop the stud.
- This knob provides rebound adjustment only.

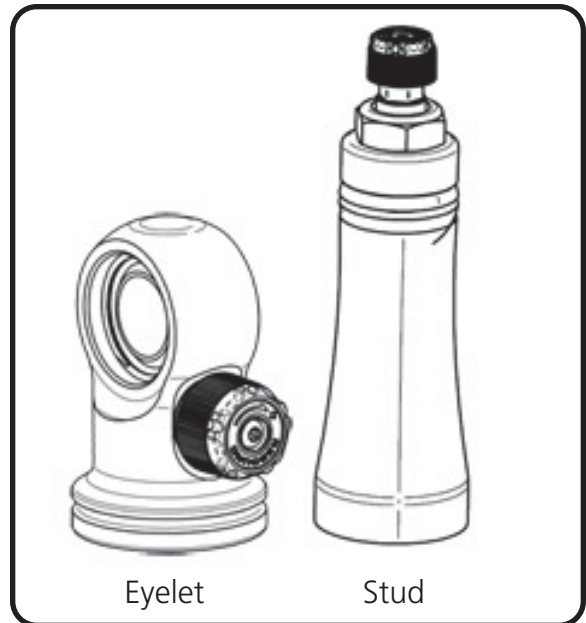

Knob Function

Counterclockwise

=
Softer

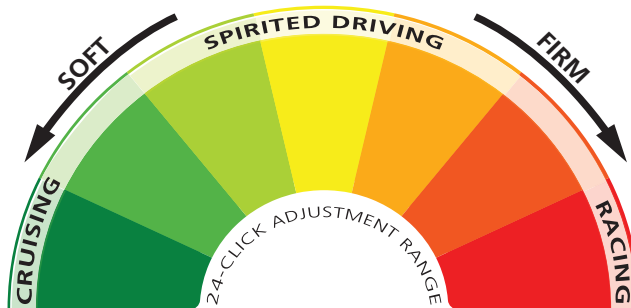

Clockwise

=
Firmer





TUNING GUIDE

SINGLE-ADJUSTABLE SHOCKS



Initial Rebound Setting

NOTE: Before jumping straight to a middle-of-the-road shock setting, we recommend you experience the full range of adjustment potential of your new shocks by first driving your vehicle at both the “full stiff” and “full soft” settings. Understanding how your shocks behave at these extremes will provide recognizable reference points as you attempt to dial in your settings.

1. Begin by setting your shocks to the “full stiff”, or minimal rebound position. You do this by turning the adjustment knob clockwise until it stops.

2. Now turn the adjustment knob counterclockwise 12 clicks. This is the approximate center of the adjustment range.

3. Take the vehicle for a test drive. Try to determine if you are experiencing any of the unwanted behaviors found at the extremes of the adjustment range. If you are satisfied with the ride quality and handling, you’re all set. Enjoy the ride!

4. If the vehicle feels too “floaty” or soft, turn the knob a few clicks clockwise to increase the damping effect.

If the ride quality is still too harsh or stiff, turn the knob a few more clicks counterclockwise to decrease the damping effect.

5. Take the vehicle for another test drive. If necessary, repeat the steps above until your desired optimal ride quality has been achieved.



General Guidelines

- The rear shocks typically have the most influence on ride quality. This is due to your seating position being closer to the rear than the front.
- Adjustments to the front shocks will generally require 3-4 clicks in any direction to be noticeable, while adjustments to the rear shocks may only require 1-2 clicks to be felt.
- Don’t be afraid to turn the knobs and experience the full adjustment range. You are not going to hurt anything and you can always go back if you adjust too far one way or the other.